

TOSHIBA

SMMS ∞

SUPER MODULAR MULTI SYSTEM

Customized for efficiency.
Customized to help you ace.



TOSHIBA AIR CONDITIONING



 **Better Air Solutions**

TOSHIBA EXPERIENCE THE FUTURE SMMS[∞]

> CUSTOMIZED FOR EFFICIENCY CUSTOMIZED TO HELP YOU ACE

Discover the next generation of efficient and flexible VRF system for sustainable cooling. Engineered in Japan, the SMMS[∞] integrates latest technological innovations and provides multiple customization options to achieve top-class efficiency and ensure unrivalled comfort.

SMMS[∞]
SUPER MODULAR MULTI SYSTEM

Enhanced Efficiency
Improved Flexibility
Superior Serviceability

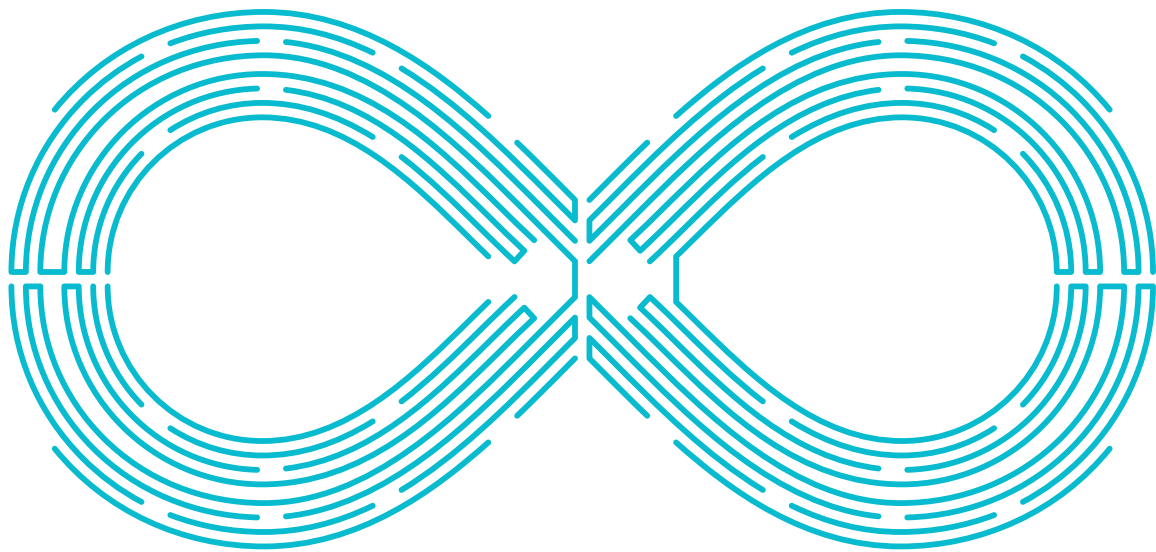

Benefits for the consultants



SMMS[∞] offers unlimited possibilities in terms of capacity, connectivity, indoor unit lineup and control solutions, providing the correct solution for your customers needs. Toshiba's intuitive selection tool will guide you through the selection process with minimal input from your side, ensuring trouble-free installation and operation.

Benefits for the users



There is nothing like a comfortable place to enjoy the present moment. Full of Toshiba innovations, the new SMMS[∞] guarantees all year round comfort combined with superior energy management, advanced air filtration and full control solutions for maximized product usability.

Benefits for the installers



The brand new chassis of SMMS[∞] is both compact and lightweight. This brand new design and technology make it easier for an installer to install SMMS[∞]. It needs simplified piping work, reduced additional refrigerant recharge, and simplified test runs. Therefore, the installer ace with this.

A BRAND NEW CHASSIS

Engineered in Japan, SMMS[∞] integrates all the latest technological innovations from Toshiba to achieve top class efficiency and ensure unrivalled comfort.

Up to 26HP single module / 120HP combination

Simplified maintenance: Easy access to main internal components

Earthquake and typhoon Durability chassis



Strong static pressure: Up to 80Pa available

Compact chassis: Only 1,690mm height

Super-efficient: Full product height heat exchanger

8 to 14HP

14A to 26HP

UNIQUE ON THE MARKET: TWIN ROTARY COMPRESSOR

The exclusive Toshiba twin rotary compressor brings outstanding performance to SMMS[∞] for enhanced system reliability.



 Large capacity

 Wide operating range

 Low required refrigerant

 Low vibration

 DLC treatment

TOP CLASS EFFICIENCY



The SMMS[∞] utilises new and improved highly efficient core technologies, resulting in greater energy efficiency and performance.

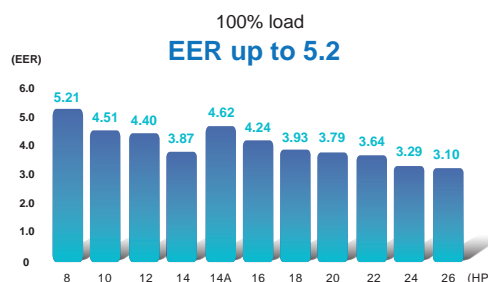
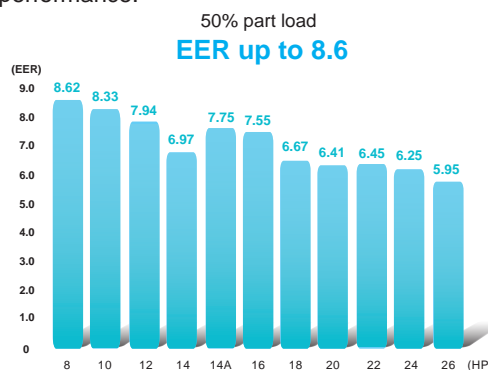

INFINITE FLEXIBILITY

The SMMS[∞] exceeds the limits of VRF for maximised project coverage, resulting in a combination that offers options on efficiency, space, and cost. Whatever your requirement, SMMS[∞] can be customized to deliver the best result for your project.

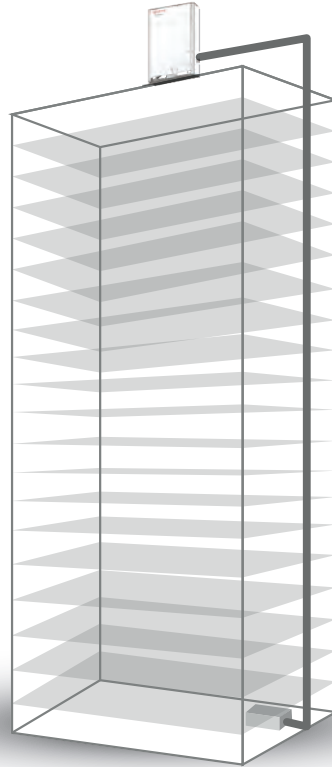

4,000 combinations patterns
Free combination

1,200m max
Long piping length

110m max
High piping lift

Up to 128 indoor
Large IDU connection

Max 120HP by 5 units
connection
Large system capacity

Max 200% combination
High diversity



> FLEXIBLE FREE COMBINATION

Combinations examples - SMMS[∞] 52HP
total 69 combinations

Unit combination can be customized to meet the installation site requirement.

Total
4000
combination
pattern
is available



Standard (Space-saving)

EER: 3.10
Width: **2,600** mm.

Balance (Space-saving)

EER: 3.95
Width: **3,610** mm.

Balance (Moderate)

EER: 4.09
Width: **4,020** mm.

Max. Highest efficiency

EER: 4.87
Width: 5,630 mm.

Balance efficiency

EER: 4.62
Width: 5,030 mm.

Note: Outdoor unit still should align from larger to smaller HP

COMFORT ABOVE ALL

Ensuring occupants comfort is SMMS[∞]'s top priority. It can connect with a wide range of indoor units adapted to any room configuration. SMMS[∞] offers the most accurate refrigerant flow management system.

> WIDE OPERATING TEMPERATURE RANGE

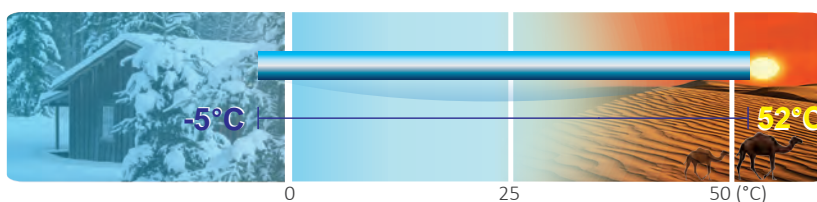

The refrigerant heat sink can bring down temperature of electronic parts. By using this new function, SMMS[∞] can operate in high ambient condition such as 52°C.

SMMS[∞] can select optimal heat exchanger size based on operating mode, outdoor temp, and capacity load. It allows SMMS[∞] to realize high efficiency, not only for full load operation but also for part load operation.

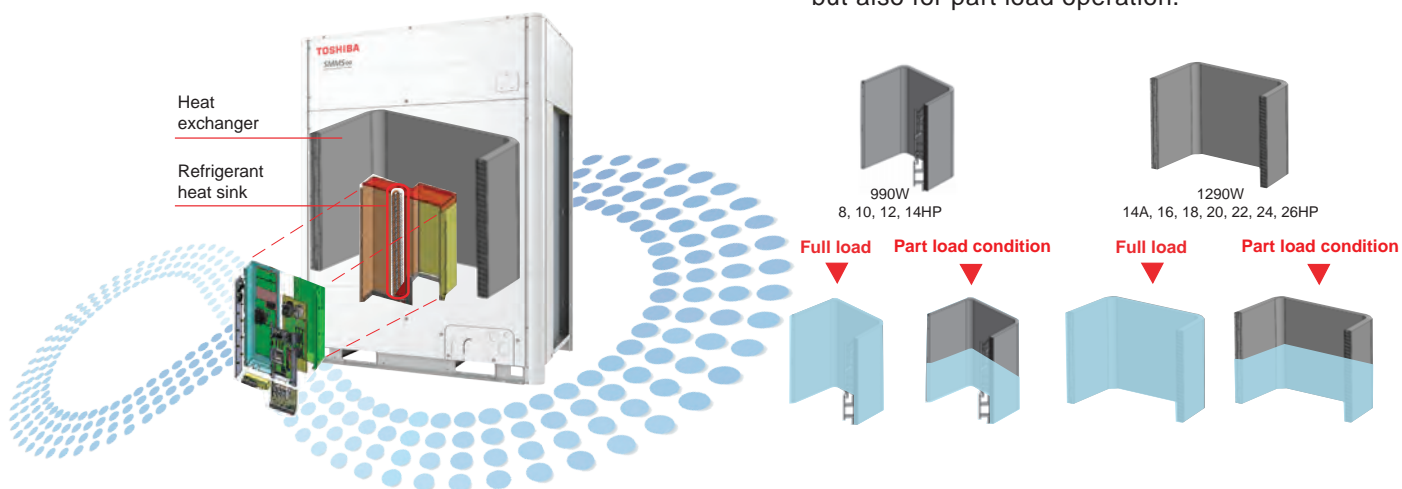

> STRONG ADAPTABILITY

SMMS[∞] integrates new features to adapt operations to local constraints with a constant target: the alliance of comfort and energy savings.



Heat exchanger usage area automatically varies depending on workload, maximizing energy savings and system reliability.

Split heat exchanger



Smart Grid ready with remote or dry contact demand control function.

Demand control



Automatic backup in case of combinations systems failure.

Auto backup function



Smart control to automatically equalize compressor operating hours.

Rotation drive



Inverter box is fully sealed up in order to avoid malfunction due to small animals.

Sealed up inverter box



Automatic refrigerant charge to minimize installation workload.

Auto refrigerant charge

INSTALLATION FLEXIBILITY

Reusable pipes and IDU

Toshiba SMMS[∞] comes with the flexibility of reusing pipes and IDU of the existing VRF solution. This flexibility lets SMMS[∞] replace any VRF solution in a shorter time. SMMS[∞] is a cost-effective solution as it allows you to replace both IDU and ODU in different intervals.

Auto refrigerant charge

Auto refrigerant recharge helps when using the existing pipes, as the pipe length may not be unknown initially. It also helps recharge the refrigerant with more accuracy and reliability.

Since it is not required to know the refrigerant filling amount in advance, it helps effective time utilization of the service team and reduces the load.



Conventional VRF

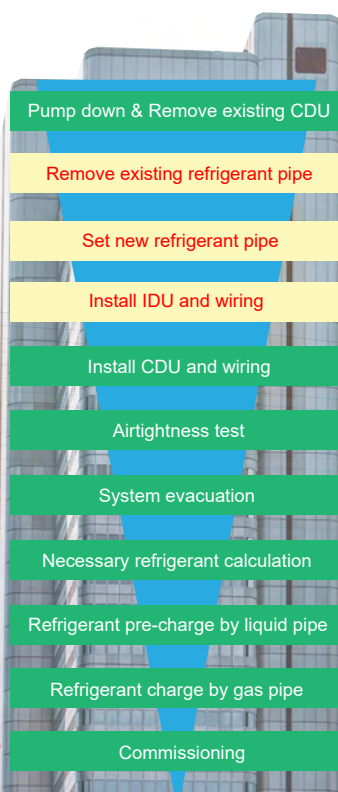

SMMS[∞]

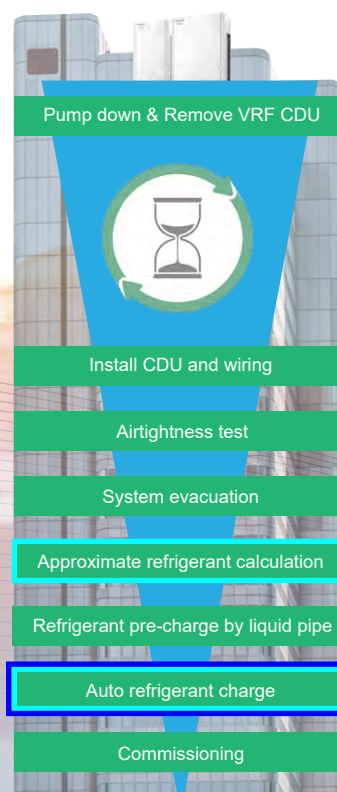

RELIABILITY

Toshiba SMMS[∞] uses a "Double-pipe subcool heat exchanger" that transforms the charging refrigerant completely from liquid to gas phase. Therefore, even during high-speed refrigerant charge conditions, SMMS[∞] reduces the risk of liquid compression.

ACCURACY

Toshiba SMMS[∞] senses temperature data through "Double-pipe subcool heat exchanger" and "IDU PMV condition" to identify the required refrigerant amount accurately.

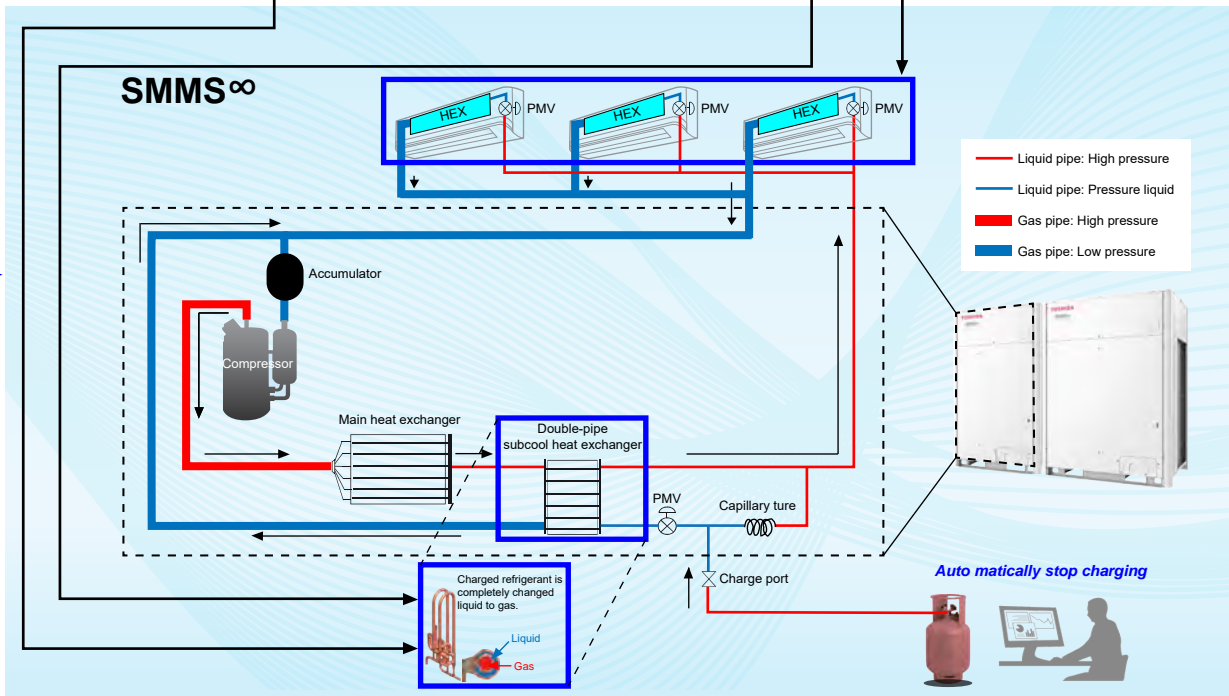

Conventional VRF

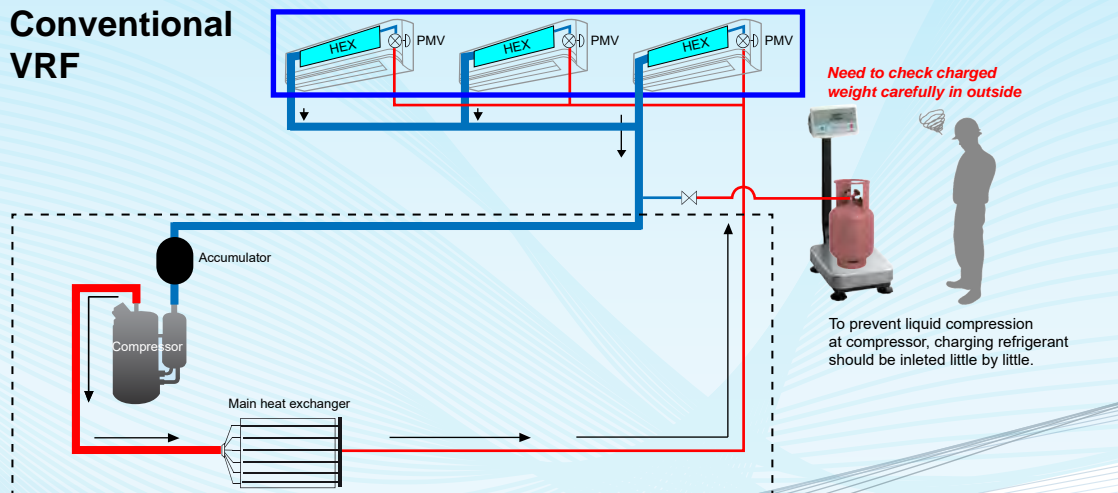

2PIPE VRF COOLING ONLY

MMY-MUP_1T8(J)P SMMS[∞]

> NEW



CAPACITY



8 HP - 120 HP

OPERATION



-5°C ~ +52°C



With new chassis, new compressor, new heat exchanger, the SMMS[∞], latest generation of Toshiba VRF, is customized for efficiency, customized to help you ace.

SMMS[∞]

Outdoor unit	MMY-	MUP0801T8P	MUP1001T8P	MUP1201T8P	MUP1401T8P	MUP14A1T8P	MUP1601T8P	MUP1801T8P	MUP2001T8P	MUP2201T8P	MUP2401T8P	MUP2601T8P
Outdoor unit (Anti-Corrosion)	MMY-	MUP0801T8JP	MUP1001T8JP	MUP1201T8JP	MUP1401T8JP	MUP14A1T8JP	MUP1601T8JP	MUP1801T8JP	MUP2001T8JP	MUP2201T8JP	MUP2401T8JP	MUP2601T8JP
		8 HP	10 HP	12 HP	14 HP	14 HP	16 HP	18 HP	20 HP	22 HP	24 HP	26 HP
Cooling capacity	kW	22.4	28.0	33.5	40.0	40.0	45.0	50.4	56.0	61.5	67.0	73.0
Power input	kW	4.30	6.21	7.61	10.34	8.66	10.61	12.82	14.78	16.90	20.36	23.55
EER (Capacity 100%)	kW/kW	5.21	4.51	4.40	3.87	4.62	4.24	3.93	3.79	3.64	3.29	3.10
EER (Capacity 50%)	kW/kW	8.62	8.33	7.94	6.97	7.75	7.55	6.67	6.41	6.45	6.25	5.95
Running current	A	6.90	9.74	11.8	15.9	13.6	16.5	19.7	22.7	26.0	31.3	36.2
Maximum overcurrent protection		20	25	25	32	40	50	50	50	63	63	63

Performances

SMMS[∞]

Outdoor unit	MMY-	MUP0801T8P	MUP1001T8P	MUP1201T8P	MUP1401T8P	MUP14A1T8P	MUP1601T8P	MUP1801T8P	MUP2001T8P	MUP2201T8P	MUP2401T8P	MUP2601T8P
Outdoor unit (Anti-Corrosion)	MMY-	MUP0801T8JP	MUP1001T8JP	MUP1201T8JP	MUP1401T8JP	MUP14A1T8JP	MUP1601T8JP	MUP1801T8JP	MUP2001T8JP	MUP2201T8JP	MUP2401T8JP	MUP2601T8JP
Air flow	m ³ /h	9900	10500	11700	11880	13750	14300	14300	15200	16500	16500	18200
Sound power level	dB(A)	76.0	77.0	79.0	82.0	80.0	82.0	82.0	83.0	86.0	86.0	88.0
Sound pressure level	dB(A)	53.0	55.0	58.0	58.0	59.0	60.0	61.0	61.0	63.0	63.0	66.0
Number of fan	unit	1	1	1	1	1	1	1	1	2	2	2
External static pressure available	Pa	80	80	80	80	80	80	80	50	80	80	80
Dimensions (h x w x d)	mm	1690 x 990 x 780	1690 x 990 x 780	1690 x 990 x 780	1690 x 990 x 780	1690 x 1290 x 780	1690 x 1290 x 780	1690 x 1290 x 780	1690 x 1290 x 780	1690 x 1290 x 780	1690 x 1290 x 780	1690 x 1290 x 780
Weight	kg	223	223	223	223	294	294	294	294	329	329	329
Compressor type		Hermetic Twin Rotary	Hermetic Twin Rotary	Hermetic Twin Rotary	Hermetic Twin Rotary	Hermetic Twin Rotary	Hermetic Twin Rotary	Hermetic Twin Rotary	Hermetic Twin Rotary	Hermetic Twin Rotary	Hermetic Twin Rotary	Hermetic Twin Rotary
Refrigerant charge R410A	kg	6.0	6.0	6.0	6.0	9.0	9.0	9.0	9.0	9.0	9.0	9.0
Gas line type - diameter	mm	Brazing - 19.1	Brazing - 22.2	Brazing - 28.6	Brazing - 28.6	Brazing - 28.6	Brazing - 28.6	Brazing - 28.6	Brazing - 28.6	Brazing - 28.6	Brazing - 34.9	Brazing - 34.9
Liquid line type - diameter	mm	Brazing - 12.7	Brazing - 12.7	Brazing - 12.7	Brazing - 15.9	Brazing - 15.9	Brazing - 15.9	Brazing - 15.9	Brazing - 15.9	Brazing - 19.1	Brazing - 19.1	Brazing - 19.1
Farthest piping equivalent length	m	210	210	210	210	210	210	210	210	210	210	210
Farthest piping real length	m	190	190	190	190	190	190	190	190	190	190	190
Maximum total piping length	m	500	500	500	500	500	500	500	500	500	500	500
Maximum lift (indoor unit above/below)	m	40 / 110 ¹	40 / 110 ¹	40 / 110 ¹	40 / 110 ¹	40 / 110 ¹	40 / 110 ¹	40 / 110 ¹	40 / 110 ¹	40 / 110 ¹	40 / 110 ¹	40 / 110 ¹
Operating range - DB	°C	-5/52	-5/52	-5/52	-5/52	-5/52	-5/52	-5/52	-5/52	-5/52	-5/52	-5/52
Power supply	V _{ph} -Hz	400(380/415)-3-50	400(380/415)-3-50	400(380/415)-3-50	400(380/415)-3-50	400(380/415)-3-50	400(380/415)-3-50	400(380/415)-3-50	400(380/415)-3-50	400(380/415)-3-50	400(380/415)-3-50	400(380/415)-3-50

Physical data

Installation space

MMY-MUP0801T8(J)P, MMY-MUP1001T8(J)P,
MMY-MUP1201T8(J)P, MMY-MUP1401T8(J)P

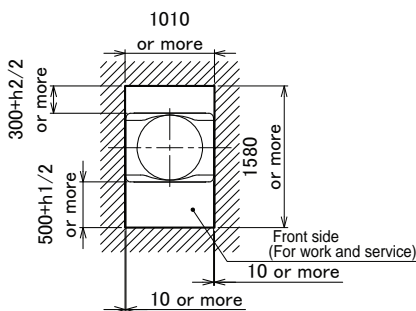

Space required for service

MMY-MUP14A1T8(J)P, MMY-MUP1601T8(J)P,
MMY-MUP1801T8(J)P, MMY-MUP2001T8(J)P

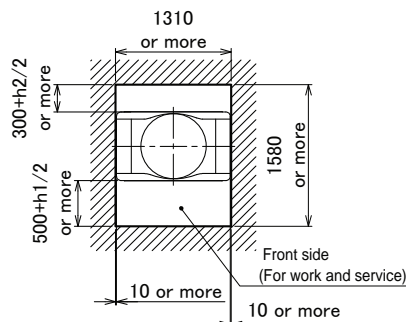

Space required for service

MMY-MUP2201T8(J)P, MMY-MUP2401T8(J)P,
MMY-MUP2601T8(J)P

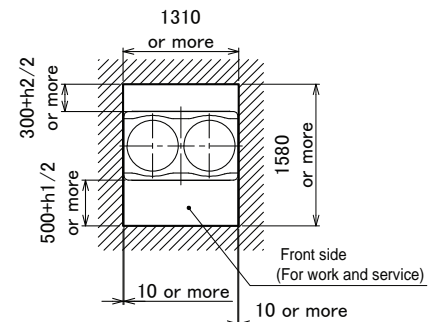

Space required for service

- Leave space necessary for running, installation and servicing.
- If there is an obstacle above the outdoor unit, leave a space of 2000 mm or more to the top end of the outdoor unit.
- If there is a wall around the outdoor unit, make sure that its height does not exceed 800 mm.

Capacity table

Capacity		Combination	Model	EER	Max Indoor connectivity
HP	Cooling (kW)				
8	22.4	-	MMY-MUP0801T8(J)P	5.21	18
10	28.0	-	MMY-MUP1001T8(J)P	4.51	22
12	33.5	-	MMY-MUP1201T8(J)P	4.40	27
14	40.0	-	MMY-MUP1401T8(J)P	3.87	31
14	40.0	-	MMY-MUP14A1T8(J)P	4.62	31
16	45.0	-	MMY-MUP1601T8(J)P	4.24	36
18	50.4	-	MMY-MUP1801T8(J)P	3.93	40
20	56.6	-	MMY-MUP2001T8(J)P	3.79	45
22	61.5	-	MMY-MUP2201T8(J)P	3.64	49
24	67.0	-	MMY-MUP2401T8(J)P	3.29	54
26	73.5	-	MMY-MUP2601T8(J)P	3.10	58
28	80.0	14 + 14	MMY-UP2811T8(J)P	3.90	63
30	83.9	18 + 12	MMY-UP3011T8(J)P	4.10	64
32	89.5	20 + 12	MMY-UP3211T8(J)P	4.00	65
34	95.0	20 + 14	MMY-UP3411T8(J)P	3.90	66
36	100.5	24 + 12	MMY-UP3611T8(J)P	3.60	67
38	106.5	26 + 12	MMY-UP3811T8(J)P	3.40	68
40	113.0	26 + 14	MMY-UP4011T8(J)P	3.30	69
42	117.5	22 + 20	MMY-UP4211T8(J)P	3.70	70
44	123.0	22 + 22	MMY-UP4411T8(J)P	3.60	71
46	128.5	24 + 22	MMY-UP4611T8(J)P	3.50	72
48	134.0	24 + 24	MMY-UP4811T8(J)P	3.30	73
50	140.0	26 + 24	MMY-UP5011T8(J)P	3.20	74
52	146.0	26 + 26	MMY-UP5211T8(J)P	3.10	75
54	151.0	22 + 20 + 12	MMY-UP5411T8(J)P	3.80	76
56	156.5	22 + 22 + 12	MMY-UP5611T8(J)P	3.80	77
58	162.0	24 + 22 + 12	MMY-UP5811T8(J)P	3.60	78
60	167.5	24 + 24 + 12	MMY-UP6011T8(J)P	3.50	79
62	174.0	24 + 24 + 14	MMY-UP6211T8(J)P	3.40	80
64	179.5	26 + 26 + 12	MMY-UP6411T8(J)P	3.30	81
66	184.5	22 + 22 + 22	MMY-UP6611T8(J)P	3.60	82
68	190.0	24 + 24 + 20	MMY-UP6811T8(J)P	3.40	83
70	195.5	24 + 24 + 22	MMY-UP7011T8(J)P	3.40	84
72	201.0	24 + 24 + 24	MMY-UP7211T8(J)P	3.30	85
74	207.0	26 + 24 + 24	MMY-UP7411T8(J)P	3.20	86
76	213.0	26 + 26 + 24	MMY-UP7611T8(J)P	3.20	87
78	219.0	26 + 26 + 26	MMY-UP7811T8(J)P	3.10	88
80	223.5	24 + 24 + 20 + 12	MMY-UP8011T8(J)P	3.60	90
82	229.0	24 + 24 + 22 + 12	MMY-UP8211T8(J)P	3.50	92
84	234.5	24 + 24 + 24 + 12	MMY-UP8411T8(J)P	3.40	94
86	240.5	26 + 24 + 24 + 14	MMY-UP8611T8(J)P	3.40	96
88	246.5	26 + 26 + 24 + 12	MMY-UP8811T8(J)P	3.30	98
90	252.5	26 + 26 + 26 + 12	MMY-UP9011T8(J)P	3.20	100
92	259.0	26 + 26 + 26 + 14	MMY-UP9211T8(J)P	3.20	102
94	262.5	24 + 24 + 24 + 22	MMY-UP9411T8(J)P	3.40	104
96	268.0	24 + 24 + 24 + 24	MMY-UP9611T8(J)P	3.30	106
98	274.5	26 + 26 + 24 + 22	MMY-UP9811T8(J)P	3.30	108
100	280.0	26 + 26 + 24 + 24	MMY-UP10011T8(J)P	3.20	110
102	286.0	26 + 26 + 26 + 24	MMY-UP10211T8(J)P	3.10	112
104	292.5	26 + 26 + 26 + 14 + 12	MMY-UP10411T8(J)P	3.30	114
106	297.0	26 + 26 + 22 + 20 + 12	MMY-UP10611T8(J)P	3.40	116
108	302.4	26 + 26 + 24 + 24 + 8	MMY-UP10811T8(J)P	3.30	118
110	308.0	26 + 26 + 24 + 22 + 12	MMY-UP11011T8(J)P	3.40	120
112	313.5	26 + 26 + 24 + 24 + 12	MMY-UP11211T8(J)P	3.30	122
114	319.5	26 + 26 + 26 + 24 + 12	MMY-UP11411T8(J)P	3.20	124
116	326.0	26 + 26 + 26 + 24 + 14	MMY-UP11611T8(J)P	3.20	126
118	329.5	24 + 24 + 24 + 24 + 22	MMY-UP11811T8(J)P	3.40	128
120	335.0	24 + 24 + 24 + 24 + 24	MMY-UP12011T8(J)P	3.30	128





Piping rules

		Allowable value		Piping section
Piping length	"Total extension of pipe (Liquid pipe, real length)"	Single ODU	500m	LA+LB+LC+La+Lb+Lc+Ld+Le+L1+L2+L3
		Combination ODU	1200m (*6)	+L4+L5+L6+L7+a+b+c+d+e+f+g+h+i+j
	Farthest piping length (*1)	Equivalent length	250m	LA+LB+LC+Le+L1+L3+L4+L5+L6+j
		Real length	210m	
	Equivalent length of farthest piping form 1st branching (*1)		90m (*2)	L3 + L4 + L5 + L6 + j
	Equivalent length of farthest piping between outdoor units		40m	LA+LB+LC+Le(LA+LB+LC+Ld)
	Max. equivalent length of main piping	Equivalent length	120m (*3)	L1
		Real length	100m (*3)	
Max. equivalent length of outdoor unit connecting piping		10m	Le(La, Lb, Lc, Ld)	
Max. real length of indoor unit connecting piping		30m	a, b, c, d, e, f, g, h, i, j	
Max. equivalent length between branches		50m	L2, L3, L4, L5, L6, L7	
Difference in height	Height between indoor and outdoor units	Upper outdoor unit	70m (*4)(*7)	-
		Lower outdoor unit	40m (*5)(*8)	-
	Height between indoor units		50m (*9)	-
	Height between outdoor units		5m	-

(*1) : (e) is outdoor unit farthest from the 1st branch and (j) is the indoor unit farthest from the 1st branch.
 (*2) : If the height difference (H1) between indoor and outdoor unit exceeds 3 m, set 65m or less.
 (*3) : If the max. combined outdoor unit capacity is 54HP or more, then max. equivalent length is 70 m or less (real length is 50 m or less).
 (*4) : If the height difference (H2) between indoor units exceeds 3 m, set 50 m or less.
 (*5) : If the height difference (H2) between indoor units exceeds 3 m, set 30 m or less.
 (*6) : Total charging refrigerant is 140kg or less.

(*7) : Extension up till 110m is possible with conditions below:
 - Single outdoor unit system
 - Connected ratio of indoor units to outdoor units is below 105%
 - Liquid side is been increased 1 size from the standard size
 - Height between indoor units is equal or less than 40 m.
 (*8) : Extension up till 110m is possible with conditions below :
 - Height between indoor units is equal or less than 3 m.
 - Connected ratio of indoor units to outdoor units is below 105%
 - Minimum capacity of connecting indoor unit is more than 3HP
 (*9) : If the connected ratio of indoor units to outdoor units is more than 105%, set 15 m.

Drawings

Unit : mm

MMY-MUP0801T8(J)P, MMY-MUP1001T8(J)P,
MMY-MUP1201T8(J)P, MMY-MUP1401T8(J)P

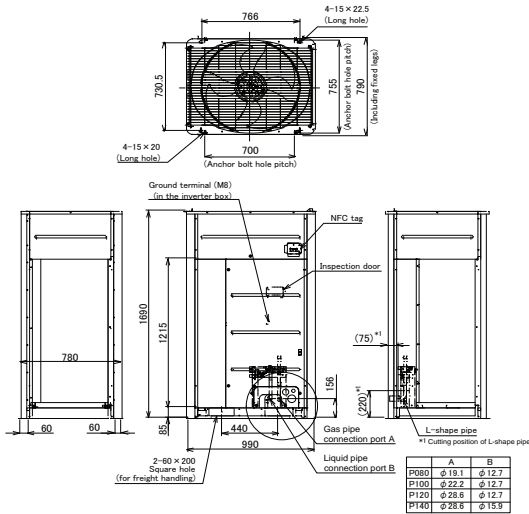

MMY-MUP14A1T8(J)P, MMY-MUP1601T8(J)P,
MMY-MUP1801T8(J)P, MMY-MUP2001T8(J)P

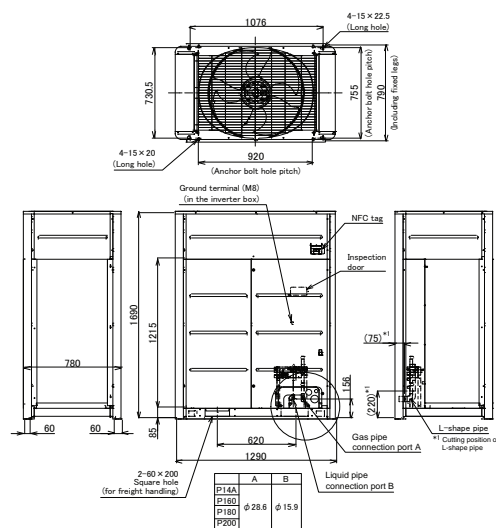

MMY-MUP2201T8(J)P, MMY-MUP2401T8(J)P,
MMY-MUP2601T8(J)P

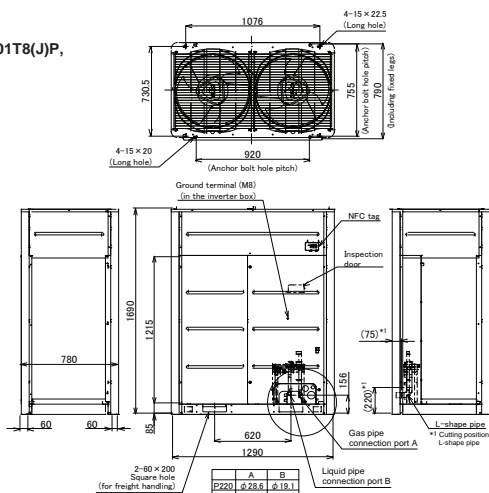

Sound pressure levels

MMY-MUP0801T8(JP)

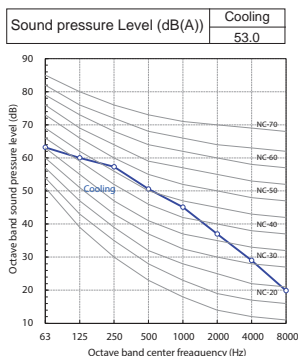

MMY-MUP1001T8(JP)

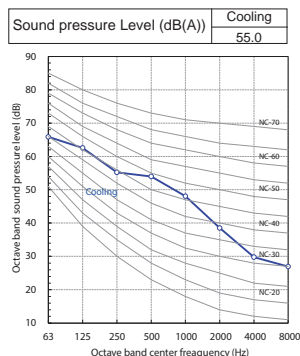

MMY-MUP1201T8(JP),
MMY-MUP1401T8(JP)

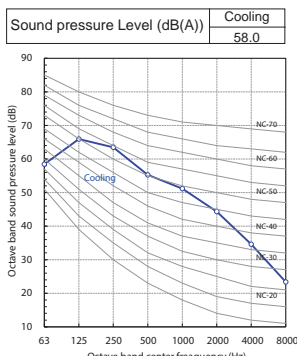

MMY-MUP14A1T8(JP)

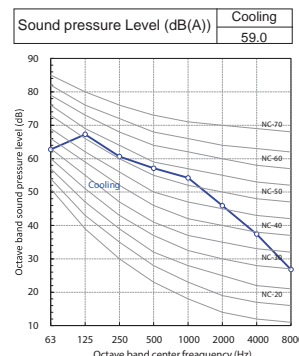

MMY-MUP1601T8(JP)

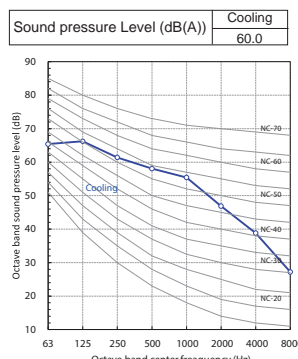

MMY-MUP1801T8(JP),
MMY-MUP2001T8(JP)

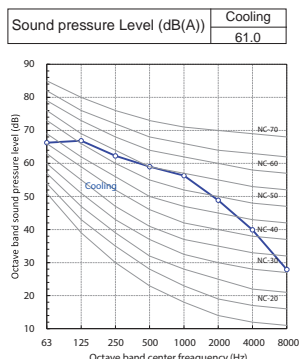

MMY-MUP2201T8(JP),
MMY-MUP2401T8(JP)

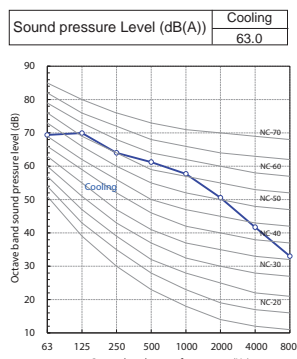

MMY-MUP2601T8(JP)

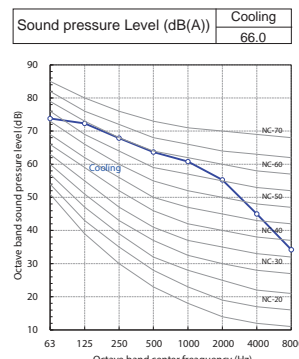

Night mode sound pressure levels

Sound reduction and approximation capacity (reference)

Type	"Night operation sound reduction dB (A)"	Cooling capacity
801	50	85%
1001	50	70%
1201	50	60%
1401	50	60%
14A1	53	70%
1601	53	70%
1801	54	65%
2001	54	60%
2201	52	55%
2401	53	55%
2601	53	55%

Condition: Cooling; (Indoor 27°DB, 19°WB) - (Outdoor temperature 25°DB)

Name	Model name	Capacity	Appearance	Remarks	
Branching joints and headers	Y-shape branching joint	RBM-BY55E	under 6.4HP		
		RBM-BY105E	from 6.4 to 14.2HP		
		RBM-BY205E	from 14.2 to 25.2HP		
		RBM-BY305E	from 25.2 to 61.2HP		
	RBM-BY405E	61.2HP or more			
	4-branching header	RBM-HY1043E	under 14.2HP		
		RBM-HY2043E	from 14.2 to 25.2HP		
	8-branching header	RBM-HY1083E	under 14.2HP		
RBM-HY2083E		from 14.2 to 25.2HP			
Branching joint for connection of outdoor units	RBM-BT14E	under 26HP			
	RBM-BT24E	from 26HP to 62HP			
	RBM-BT34E	62HP or more			
Optional PCB of outdoor unit	TCB-PCDM4E			Limit capacity of the VRF outdoor unit at 85%, 75%, 70% or 60% load or stop it. Dry contact	
	TCB-PCMO4E			Dry contact	
	TCB-PCIN4E			Operation output : The operation indicator is on while any indoor unit in the system is operating. Error output : The error indicator is on when an error is occurred on even one of the indoor or outdoor units in the system. Dry contact	

WIDE CHOICE INDOOR UNITS

> LARGE INDOOR UNIT LINE-UP

The wide range of indoor units help enhanced design flexibility and lower costs, ensuring efficiency in installing a perfect system.

- 18 different types of indoor units
- Capacity from 0.8 HP to 20 HP
- For cooling and fresh air production

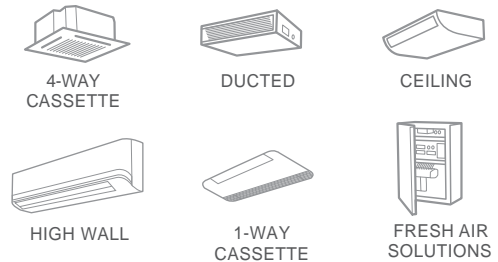

> SUPERIOR AIR COMFORT

Cool comfort with soft cooling mode

The development of the soft cooling mode provides a new level of cooling to personalize the air flow intensity, angle and direction directly from the remote control and enjoy the indoor environment at the right temperature without being exposed to the direct cold draft.

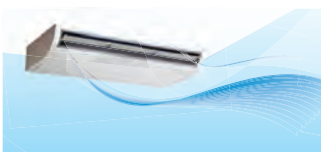

Special coated for IDU heat exchanger

With a specially coated heat exchanger, Toshiba IDU provides odorless and fresh air always. This special coating enables the dust particles on the heat exchanger to be washed out along with condensed water.

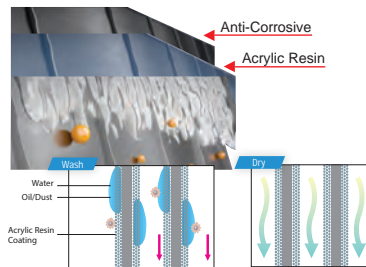

Air purifier solution

Air purifier kit removes small particles by high-quality filter and Plasma solution. This new solution traps mold, pollen and PM2.5 particle by electrostatic force. Moreover, the users are notified of the air quality level by the LED indicator color.

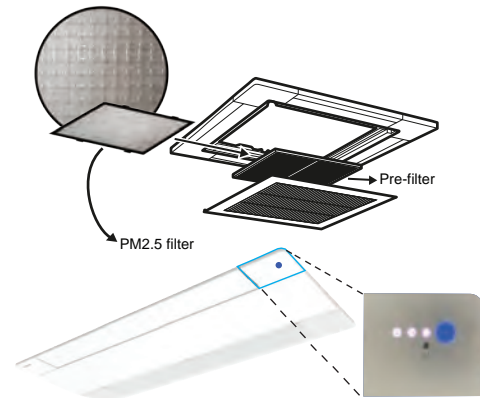

Low consumption for low operation cost

Premium comfort doesn't mean high power consumption. By using DC motor, large air discharge surface and resin coating system, Toshiba reduces drastically the indoor unit power consumption.

Color	Blue	Green	Yellow	Red
Air quality category	GOOD	Moderate	Unhealthy	Very Unhealthy

Example for Compact 4-Way Cassette (0.8HP)



	PCB	FAN	DRAIN	TOTAL
Low fan speed	4 W	6 W	3 W	13 W
Medium fan speed	4 W	7 W	3 W	14 W
High fan speed	4 W	9 W	3 W	16 W

CHOOSE YOUR ADAPTED SYSTEM SOLUTION

NEW indoor units

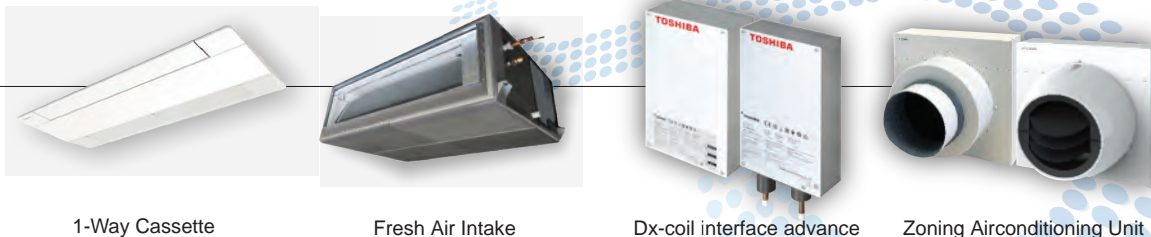

1-Way Cassette

Fresh Air Intake

Dx-coil interface advance

Zoning Airconditioning Unit

NEW Air purifier solution



PM2.5 filter 4-Way Cassette

Air purifier kit 1-Way Cassette

Air purifier kit 4-Way Cassette

PM2.5 dust sensor Air Quality Indicator

- Blue : Air quality "Good"
- Green : Air quality "Moderate"
- Yellow : Air quality "Unhealthy"
- Red : Air quality "Very Unhealthy"

SMMS∞ Indoor units

Model	(HP)	0.8	1.0	1.25	1.7	2.0	2.5	3.0	3.2	4.0	5.0	6.0	8.0	10.0	12.0	14.0	16.0	18.0	20.0
	(kW)	2.2	2.8	3.6	4.5	5.6	7.1	8.0	9.0	11.2	14.0	16.0	22.4	28.0	34.0	40.0	45.0	50.4	56.0
4-way Cassette High performance MMU-UP_1H-E		[Bar chart showing capacity range from 1.0 to 16.0 HP]																	
4-way Cassette MMU-UP_1HP-E		[Bar chart showing capacity range from 1.0 to 16.0 HP]																	
Compact 4-way Cassette MMU-UP_1MH-E		[Bar chart showing capacity range from 1.0 to 3.6 HP]																	
2-way Cassette MMU-UP_1WH-E		[Bar chart showing capacity range from 1.0 to 16.0 HP]																	
1-way Cassette MMU-UP_1YHP-E		[Bar chart showing capacity range from 1.0 to 9.0 HP]																	
Slim Duct MMD-UP_1SPHY-E		[Bar chart showing capacity range from 1.0 to 9.0 HP]																	
Concealed Duct MMD-UP_1BHP-E		[Bar chart showing capacity range from 1.0 to 16.0 HP]																	
Concealed Duct High Static Pressure MMD-UP_1HP-E(1)		[Bar chart showing capacity range from 2.0 to 10.0 HP]																	
Fresh Air Intake MMD-UP_1HFP-E(1)		[Bar chart showing capacity range from 4.0 to 14.0 HP]																	
Ceiling MMC-UP_1HP-E		[Bar chart showing capacity range from 1.25 to 6.0 HP]																	
High Wall MMK-UP_1HP-E		[Bar chart showing capacity range from 1.0 to 6.0 HP]																	
Zoning Airconditioning Unit MMZ-UP_1F/D		[Bar chart showing capacity range from 1.0 to 1.0 HP]																	
Floor Standing Concealed MML-UP_1BH-E		[Bar chart showing capacity range from 1.0 to 3.6 HP]																	
Floor Standing Cabinet MML-UP_1H-E		[Bar chart showing capacity range from 1.0 to 5.6 HP]																	
Console MML-UP_1NHP-E		[Bar chart showing capacity range from 1.0 to 5.6 HP]																	
Floor Standing MMF-UP_1H-E		[Bar chart showing capacity range from 1.25 to 6.0 HP]																	
Large Capacity Floor Standing*1 MMF-AP_5(D)HP-VA/VB		[Bar chart showing capacity range from 8.0 to 20.0 HP]																	
Air-to-Air Heat exchanger with DX-coil *1 MMD-VN_2HEX1E(2)		[Bar chart showing capacity range from 1.25 to 6.0 HP]																	
Dx-coil interface advance TCB-IFDMX01UP-E & RBM-A_1UPVA-E		[Bar chart showing capacity range from 8.0 to 20.0 HP]																	

Model	Air flow in m3/h	150	250	350	500	650	800	1000	1500	2000	
Air-to-Air Heat exchanger *1 VN-M_0HE		[Bar chart showing air flow range from 150 to 2000 m3/h]									

● New chassis

*1: Because these models can support only old communication protocol, please communicate with local distributor if you want to connect these indoor units.

IAQ SOLUTION

> PARTICLE SIZE OF PM2.5

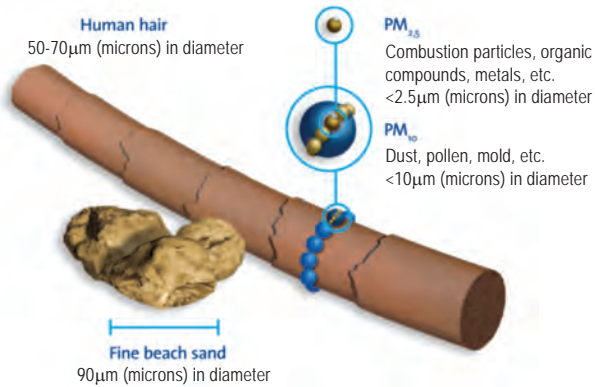

> IMPACT FOR...

Impact for air conditioner

The accumulation of dust particles on the heat exchanger reduces the overall efficiency of air conditioners and air volume. It leads to poor indoor air quality and impacts the health of occupants. It also reduces the life span of the air conditioner.



Impact for human health

PM2.5 particles have risk to penetrate deep into the respiratory tract. Moreover, some particles may even get into the bloodstream and causing severe health damage.

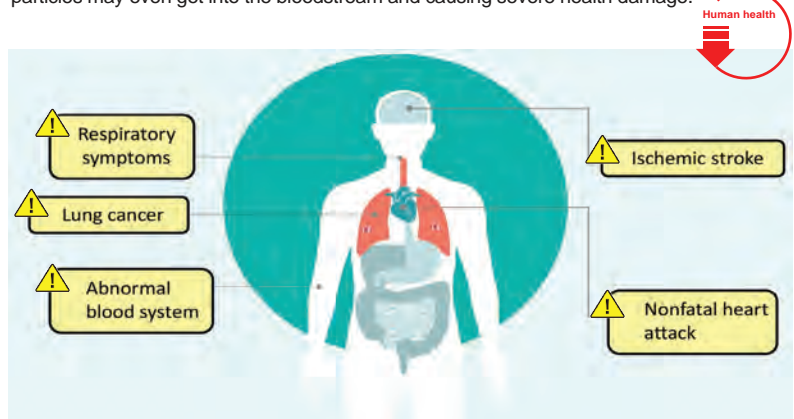

> SOLUTION TO...

Solution to keep the heat exchanger of indoor unit stays clean always

Acrylic resin coated heat exchanger enables the dust particles on the fin to be washed out along with drain water. This keeps the heat exchanger always clean, with better cooling performance.

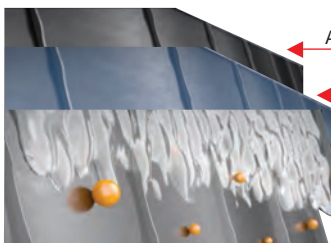
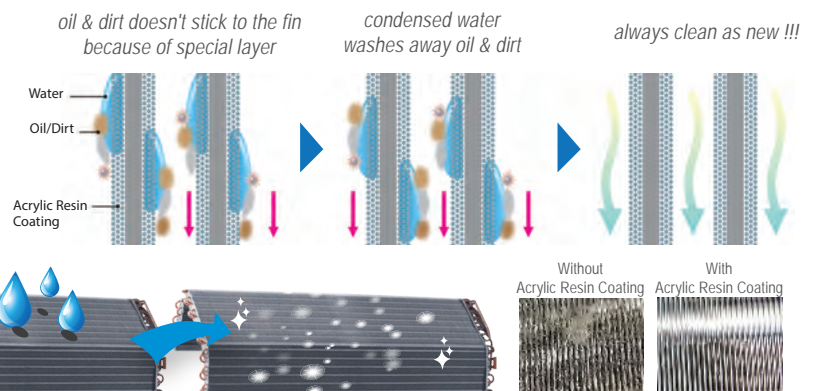

INDOOR AIR QUALITY SOLUTION

> SOLUTION TO...

Solution to keep the indoor air clean

NEW PM2.5 filter

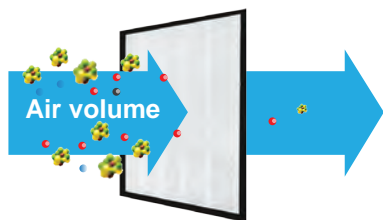

Air purifier performance Satisfactory
Air volume Satisfactory

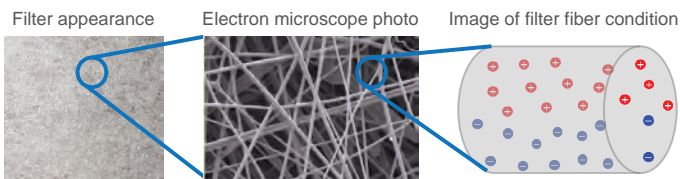

PM2.5 filter has "Electrostatic" solution. Each fiber of PM2.5 filter captures PM2.5 particles by Electrostatic force, achieving effective filtration despite a thinner filter.

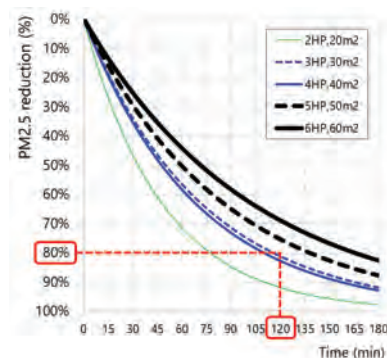
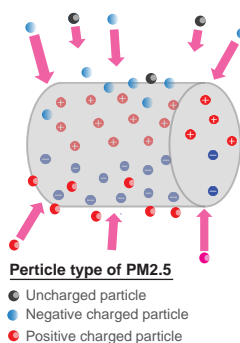

NEW Plasma Air purifier (1way cassette)

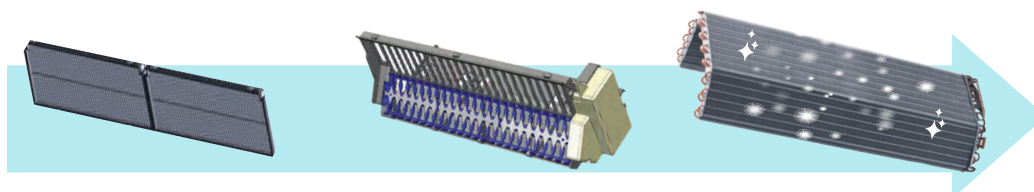

Pre-filter
Pre filter captures the large dust particles

Plasma Air purifier

Resin coated heat exchanger

Due to the special coating on the heat exchanger, the pollutants do not accumulate and get drained out with condensing water.

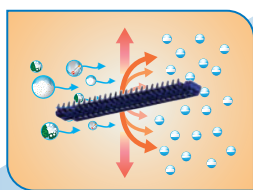

Plasma ionizer forces impurities to adopt a negative electrical charge



Pollutants become negative charge

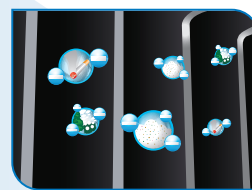

Negatively charged pollutants get attracted towards the heat exchanger.

The dust sensor detects PM2.5 and PM10 concentrations and sends PM concentration data to the Air Quality indicator. The Air Quality indicator then displays the color basis whatever is maximum between PM2.5 and PM10 as per the following criteria:

Color	Blue	Green	Yellow	Red
Air quality category	GOOD	Moderate	Unhealthy	Very Unhealthy
PM 2.5 (µg/m³)	0-15	16-35	36-75	> 76
PM 10 (µg/m³)	0-30	31-80	81-150	> 151

MMU-UP_1H-E 4-WAY CASSETTE HIGH PERFORMANCE



High efficiency 4-Way Cassette, simple and elegant design which fits various indoor space. It has a unique flap style for optimal air distribution.

CAPACITY
↑
1 HP - 6 HP

SOUND PRESSURE LEVEL
🔊
26 dB(A)

LOCAL CONTROLS



RBC-AXU41U-E



RBC-ASCU11-E
RBC-AMTU31-E
RBC-AMSU1-E/ENES

Features

Model name	MMU-	Standard										High efficiency		
		UP0091H-E	UP0121H-E	UP0151H-E	UP0181H-E	UP0241H-E	UP0271H-E	UP0301H-E	UP0361H-E	UP0481H-E	UP0561H-E	UP0092	UP0122	
Capacity code	HP	1.0	1.25	1.7	2.0	2.5	3.0	3.2	4.0	5.0	6.0	1.0	1.25	
Cooling capacity	kW	2.8	3.6	4.5	5.6	7.1	8.0	9.0	11.2	14.0	16.0	2.8	3.6	
Electrical characteristics	Power supply	1-phase 230V (220-240V) 50Hz / 1-phase 220V (208-230V) 60Hz												
	Running current (50Hz/60Hz)	A	0.17/0.18		0.19/0.20	0.25/0.26	0.36/0.38	0.46/0.48	0.57/0.60	0.90/0.94	0.92/0.96	0.93/0.97	0.20/0.21	0.20/0.21
	Power consumption (50Hz/60Hz)	kW	0.020/0.020		0.018/0.018	0.026/0.026	0.042/0.042	0.054/0.054	0.068/0.068	0.125/0.125	0.135/0.135	0.137/0.137	0.023/0.023	0.023/0.023
	Starting current (50Hz/60Hz)	A	0.26/0.27		0.29/0.30	0.37/0.39	0.55/0.57	0.69/0.72	0.86/0.90	1.35/1.41	1.38/1.44	1.40/1.46	0.30/0.32	0.30/0.32
Appearance	Main unit	Heat-insulating material attached - Zinc hot dipping steel plate												
	Ceiling panel name	RBC-U41PG(W)-E												
	Panel color	Gran White (Munsell 5PB9/1)												
Outer dimensions	Main unit (HxWxD)	mm	256x840x840				319x840x840				256x840x840			
	Ceiling panel (HxWxD)	mm	30x950x950											
Total weight	Main unit	kg	18				25				20			
	Ceiling panel	kg	5											
Heat exchanger	Finned tube													
Soundproof / Heat-insulating material	Non-flammable insulation													
Fan unit	Fan	Turbo fan												
	Standard air flow (H/M/L)	m³/h	846/768/708		1060/920/800	1260/1100/940	1580/1300/1120	1770/1380/1250	1940/1520/1400	2184/1596/1260	2262/1740/1368	2262/1782/1404	910/820/708	
	Motor output	W	60				130				60			
Sound pressure level (H/M/L)	dB(A)	30/28/26		32/30/28	36/33/31	41/37/35	42/37/35	44/39/37	45/38/32	46/39/33	46/40/35	35/33/30		
Sound power level	dB(A)	45		46	50	55	56	58	60	61	61	50		
Air filter	Standard filter supplied (Long life filter)													
Controller (Optional)	Wired or infrared remote controller													
Connecting pipe	Gas side	mm	9.5	9.5	12.7	12.7	15.9	15.9	15.9	15.9	15.9	9.5	9.5	
	Liquid side	mm	6.4	6.4	6.4	6.4	9.5	9.5	9.5	9.5	9.5	6.4	6.4	
	Drain port (nominal dia)	mm	25 (Polyvinyl chloride tube)											

Drawings

Unit : mm

MMU-UP0091H-E to MMU-UP0121H-E
MMU-UP0092 to MMU-UP0122

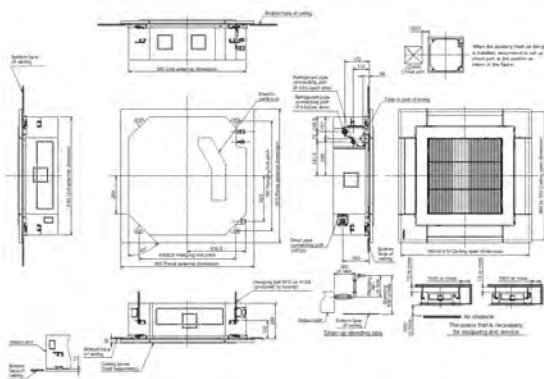

MMU-UP0151H-E to MMU-UP0561H-E

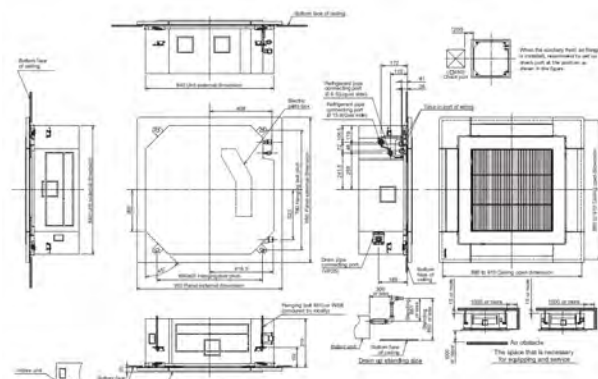

4-WAY CASSETTE HIGH PERFORMANCE

Sound pressure levels

Unit : dB(A)

MMU-UP0091, 0121H-E

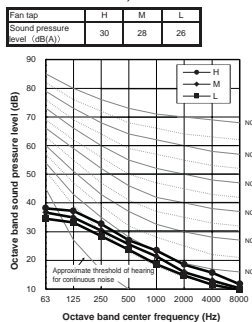

MMU-UP0151H-E

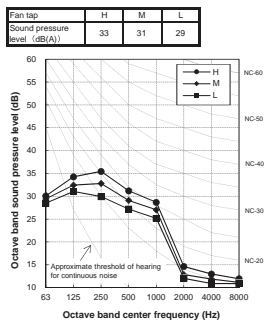

MMU-UP0181H-E

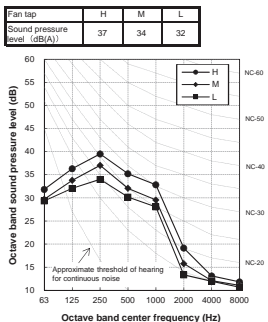

MMU-UP0241H-E

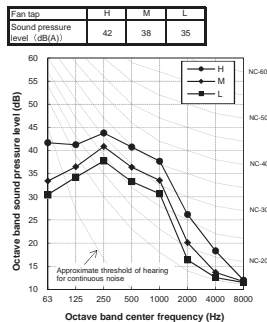

MMU-UP0271H-E

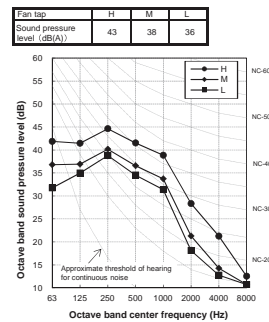

MMU-UP0301H-E

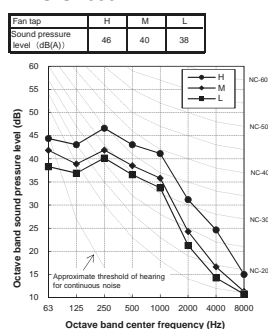

MMU-UP0361H-E

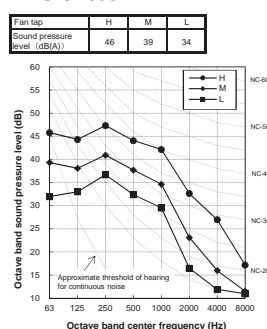

MMU-UP0481H-E

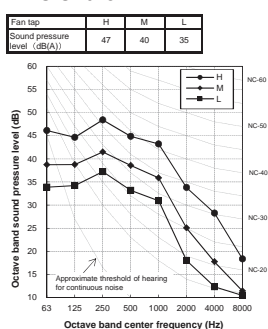

MMU-UP0561H-E

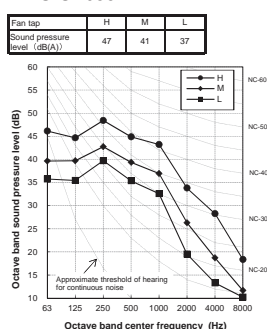

MMU-UP0092, 0122

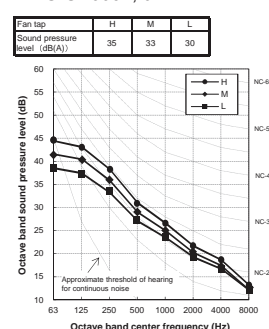

Air diffusion

Unit : m/s

MMU-UP0091, 0121H-E
MMU-UP0092, 0122

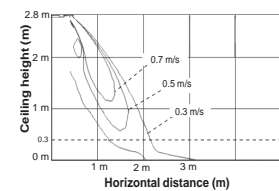

MMU-UP0151H-E

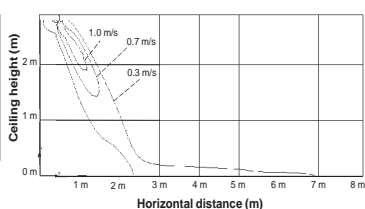

MMU-UP0181H-E

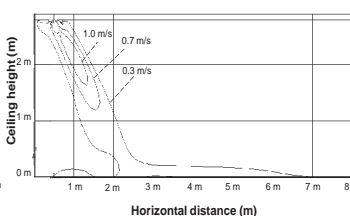

MMU-UP0241H-E

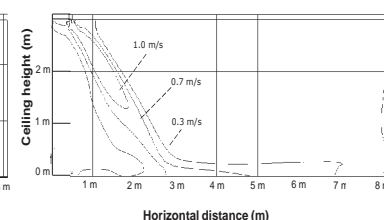

MMU-UP0271H-E

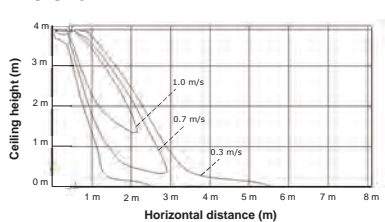

MMU-UP0301H-E

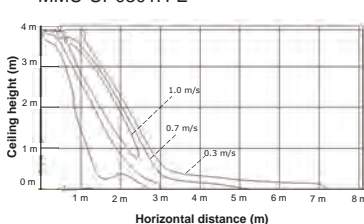

MMU-UP0361, 0481, 0561H-E

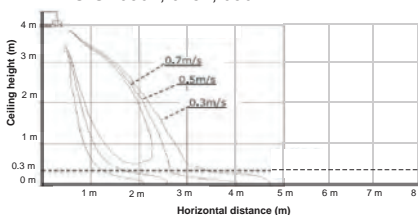

Accessories

No.	Part name	Model name	Applied model	Notes	Remarks
1	Ceiling panel	RBC-U41PG(W)-E	MMU-UP_1H-E	Required accessory	
2	Wireless remote controller	RBC-AXU41U-E		For installing on panel	
3	Wireless remote controller	RBC-AXU31-E		For installing as stand alone	
4	Fresh air chamber	TCB-GFC1603UE			
5	Space for height adjustment	TCB-SP1603UE			
6	Air discharge direction kit	TCB-BC1603UE			
7	Occupancy sensor	TCB-SIR41U-E			

4-way cassette high performance connectors

• Available

CN32	CN60	CN61	CN70	CN73	CN80
Additional ventilation control from remote control	Operation status signal output (Cooling, fan, thermo-on)	External On/Off, operation output and alarm output	Warning symbol on remote control based on signal input.	Forced IDU thermo-off based on signal input	Forced IDU thermo-off and IDU lock based on signal input
•	•	•	•	•	•

MMU-UP_1HP-E 4-WAY CASSETTE



The 4-Way Cassette is designed to provide uniform air distribution and total user comfort. It is ideal for small commercial applications.

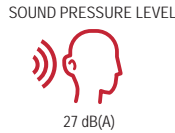

LOCAL CONTROLS



RBC-AXU31-E
RBC-AXU31U-E



RBC-ASCU11-E
RBC-AMTU31-E
RBC-AMSU51-EN/ES

Features

Model name	MMU-	UP0091HP-E	UP0121HP-E	UP0151HP-E	UP0181HP-E	UP0241HP-E	UP0271HP-E	UP0301HP-E	UP0361HP-E	UP0481HP-E	UP0561HP-E	
Capacity code	HP	1.0	1.25	1.7	2.0	2.5	3.0	3.2	4.0	5.0	6.0	
Cooling capacity	kW	2.8	3.6	4.5	5.6	7.1	8.0	9.0	11.2	14.0	16.0	
Electrical characteristics	Power supply	1-phase 230V (220-240V) 50Hz / 1-phase 220V (208-230V) 60Hz										
	Running current (50Hz/60Hz)	A	0.23/0.24		0.28/0.29	0.29/0.30	0.38/0.40	0.38/0.39	0.43/0.45	0.73/0.76	0.88/0.92	
	Power consumption (50Hz/60Hz)	kW	0.021/0.021		0.023/0.023	0.026/0.026	0.036/0.036		0.043/0.043	0.088/0.088	0.112/0.112	
	Starting current (50Hz/60Hz)	A	0.30/0.30		0.33/0.33	0.36/0.36	0.42/0.42		0.59/0.59	0.87/0.87	1.23/1.23	1.26/1.26
Appearance	Main unit	Heat-insulating material attached - Zinc hot dipping steel plate										
	Ceiling panel name	Standard panel: RBC-U32PGP-E / Smart panel: RBC-U33P-E										
	Panel color	Standard panel: White (Munsell: 2.5GY9.0/0.5) / Smart panel: Gran White (Munsell 5PB9/1)										
Outer dimensions	Main unit (HxWxD)	mm							256x840x840		319x840x840	
	Ceiling panel (HxWxD)	mm										30x950x950
Total weight	Main unit	kg			18				20		25	
	Ceiling panel	kg										4
Heat exchanger	Finned tube											
Soundproof / Heat-insulating material	Non-flammable insulation											
Fan unit	Fan	Turbo fan										
	Standard air flow (H/M/L)	m³/h		800/730/680	930/830/790	1050/920/800	1290/920/800	1320/1100/850	1970/1430/1070	2130/1430/1130	2130/1520/1230	
	Motor output	W		14			20		68		72	
Sound pressure level (H/M/L)	dB(A)		30/29/27	31/29/27	32/29/27	35/31/28	38/33/30	43/38/32	46/38/33	46/40/33		
Sound power level	dB(A)		45	46	47	50	53	58	61	61		
Air filter	Standard filter supplied (Long life filter)											
Controller (Optional)	Wired or infrared remote controller											
Connecting pipe	Gas side	mm		9.5	9.5	12.7	12.7	15.9	15.9	15.9	15.9	
	Liquid side	mm		6.4	6.4	6.4	6.4	9.5	9.5	9.5	9.5	
	Drain port (nominal dia)	mm										

Drawings

RBC-U32PGP-E

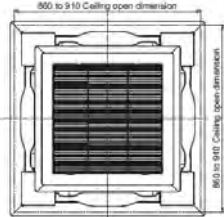

RBC-U33P-E

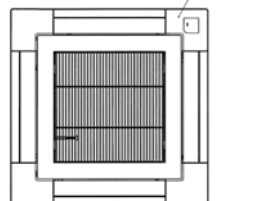

MMU-UP0091HP-E to MMU-UP0301HP-E

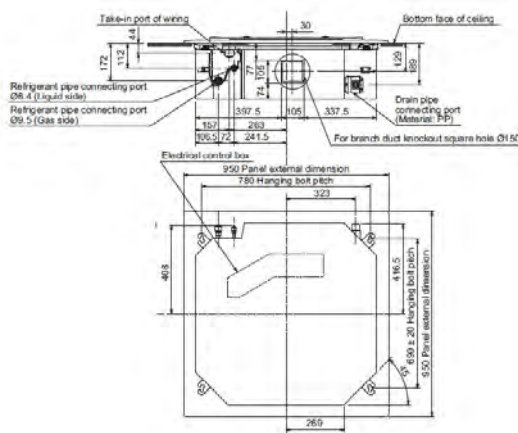

MMU-UP0361HP-E to MMU-UP0561HP-E

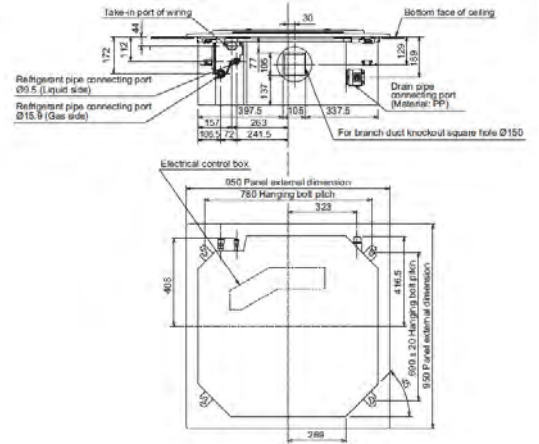

Unit : mm

4-WAY CASSETTE

Sound pressure levels

Unit : dB(A)

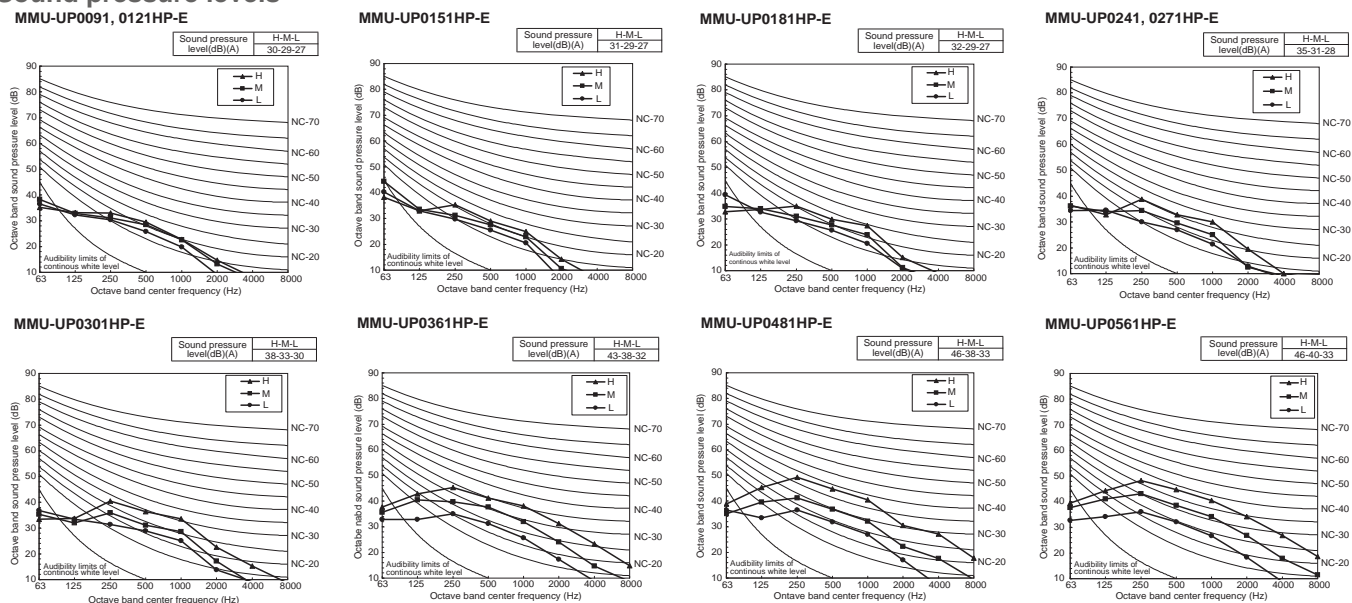

Air diffusion

Unit : m/s

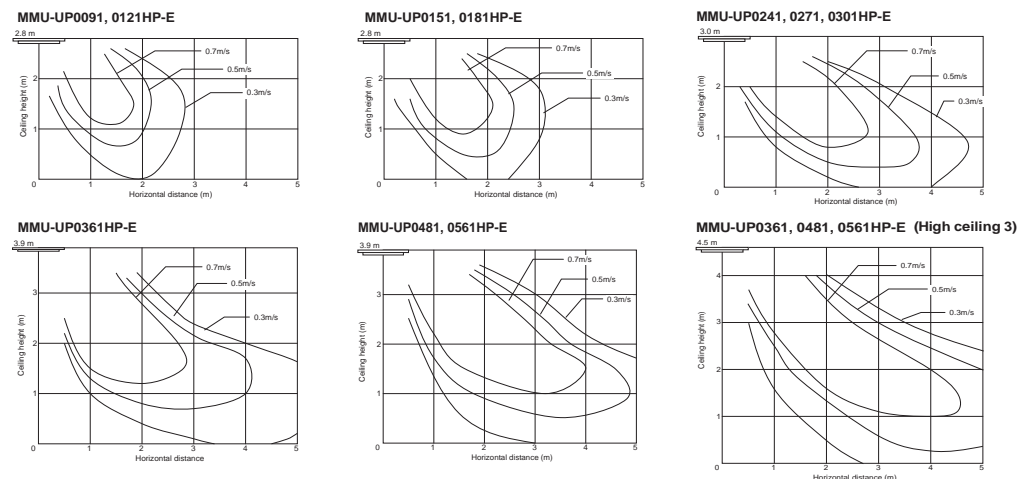

Accessories

No.	Part name	Model name	Applied model	Notes	Remarks
1	Ceiling panel (Wide-flow louver)	RBC-U32PGP-E	MMU-UP_1HP-E	Required accessory	
2	Ceiling panel (Smart design)	RBC-U33P-E		Required accessory	
3	Wireless remote controller	RBC-AXU31U-E		For Installing on panel	Use with RBC-U32PGP-E
4	Wireless remote controller	RBC-AXU31-E		For installing as stand alone	
5	Fresh air chamber	TCB-GFC1602UE			Use with TCB-GB1602UEE
6	Fresh air inlet box	TCB-GB1602UE		For fresh air intake by using the knockout hole of Fresh air and filter chamber. (dia.=100 mm)	Use with TCB-GFC1602UE
7	Auxiliary fresh air flange	TCB-FF101URE2		For easy fresh air intake by using the knockout hole of indoor unit. (dia.=100mm)	
8	Space for height adjustment	TCB-SP1602UE		Height 50 mm	
9	Air discharge direction kit	TCB-BC1602UE		Air direction change by cutting off air discharge port (3 pcs.)	
10	PM2.5 filter	TCB-PLFC1UPE-120		Before Pre-Filter type	
11	PM2.5 filter	TCB-PLFC2UPE-80		After Pre-Filter type	
12	Wireless remote controller	RBC-AXU33UP-E		*New product and coming soon	Use with RBC-U33P-E
13	Occupancy sensor	TCB-SIR33UP-E		*New product and coming soon	Use with RBC-U33P-E
14	Air purifier kit	TCB-EACP1UCP-E		*New product and coming soon	Use with RBC-U33P-E

4-way cassette connectors

• : Available

CN32	CN60	CN61	CN70	CN73	CN80
Additional ventilation control from remote control	Operation status signal output (Cooling, fan, thermo-on)	External On/Off, operation output and alarm output	Warning symbol on remote control based on signal input.	Forced IDU thermo-off based on signal input	Forced IDU thermo-off and IDU lock based on signal input
•	TCB-PCUC2E PCB needed	•	•	•	•

MMU-UP_1MH-E COMPACT 4-WAY CASSETTE



The Compact 4-Way Cassette is especially designed for office applications, where a compact and efficient solution is required.

CAPACITY



0.8 HP - 2 HP

SOUND PRESSURE LEVEL



29 dB(A)

LOCAL CONTROLS



RBC-AXU31-E
RBC-AXU31UM-E



RBC-ASCU11-E
RBC-AMTU31-E
RBC-AMSU51-ENES

Features

Model name	MMU-	UP0071MH-E	UP0091MH-E	UP0121MH-E	UP0151MH-E	UP0181MH-E	
Capacity code	HP	0.8	1.0	1.25	1.7	2.0	
Cooling capacity	kW	2.2	2.8	3.6	4.5	5.6	
Electrical characteristics	Power supply	1-phase 230V (220-240V) 50Hz / 1-phase 220V (208-230V) 60Hz					
	Running current (50Hz/60Hz)	A	0.23/0.23	0.24/0.24	0.25/0.25	0.28/0.26	0.46/0.46
	Power consumption (50Hz/60Hz)	kW	0.023/0.023	0.025/0.025	0.027/0.027	0.030/0.030	0.052/0.052
	Starting current (50Hz/60Hz)	A	0.41/0.41	0.43/0.43	0.44/0.44	0.50/0.47	0.80/0.81
Appearance	Main unit	Zinc hot dipping steel plate (Heat-insulating material attached to only upper plate)					
	Ceiling panel name	RBC-UM21PG(W)-E					
	Panel color	Gran White (Munsell 5PB9/1)					
Outer dimensions	Main unit (HxWxD)	mm 256x575x575					
	Ceiling panel (HxWxD)	mm 12x620x620					
Total weight	Main unit	kg 15					
	Ceiling panel	kg 2.5					
Heat exchanger		Finned tube					
Soundproof / Heat-insulating material		Non-flammable insulation					
Fan unit	Fan	Turbo fan					
	Standard air flow (H/M/L)	m³/h	552/462/378	570/468/378	594/504/402	660/552/468	840/642/522
	Motor output	W	60				
Sound pressure level (H/M/L)	dB(A)	37/33/29	38/33/29	38/34/30	40/35/31	47/39/34	
Sound power level	dB(A)	52	53	53	55	62	
Air filter		Standard filter supplied (Long life filter)					
Controller (Optional)		Wired or infrared remote controller					
Connecting pipe	Gas side	mm	9.5	9.5	9.5	12.7	12.7
	Liquid side	mm	6.4	6.4	6.4	6.4	6.4
	Drain port (nominal dia)	mm	VP20 (Polyvinyl chloride tube)				

Drawings

Unit : mm

All model

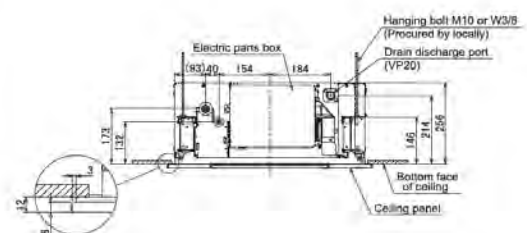
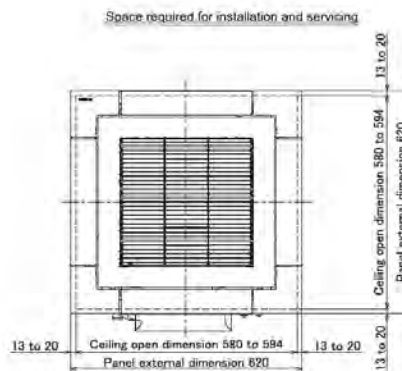
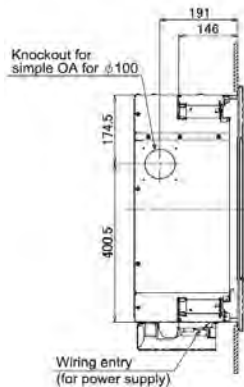

COMPACT 4-WAY CASSETTE

Sound pressure levels

Unit : dB(A)

MMU-UP0071MH-E				
Fan tap	H	M	L	
Sound pressure level (dB(A))	37	33	29	

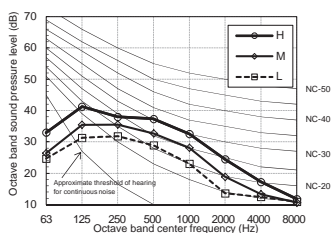

MMU-UP0091MH-E				
Fan tap	H	M	L	
Sound pressure level (dB(A))	38	33	29	

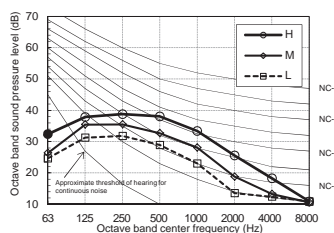

MMU-UP0121MH-E				
Fan tap	H	M	L	
Sound pressure level (dB(A))	38	34	30	

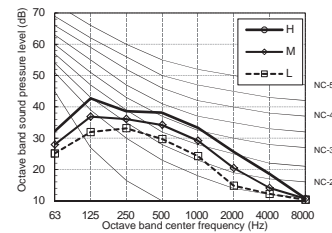

MMU-UP0151MH-E				
Fan tap	H	M	L	
Sound pressure level (dB(A))	40	35	31	

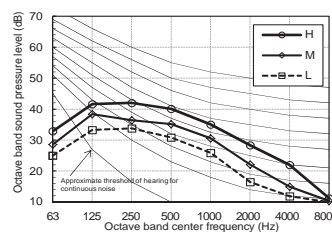

MMU-UP0181MH-E				
Fan tap	H	M	L	
Sound pressure level (dB(A))	47	39	34	

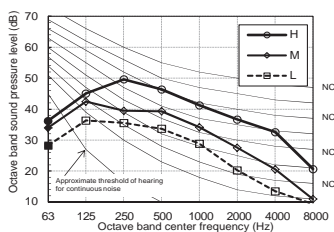

Air diffusion

Unit : m/s

MMU-UP0071MH-E

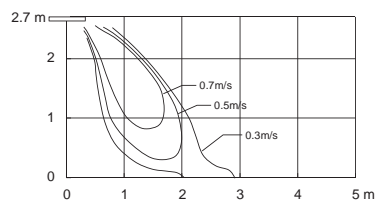

MMU-UP0091MH-E

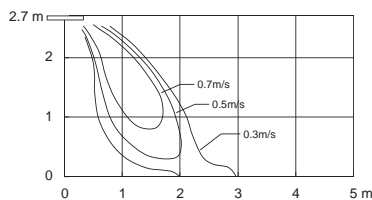

MMU-UP0121MH-E

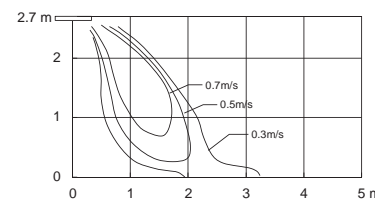

MMU-UP0151MH-E

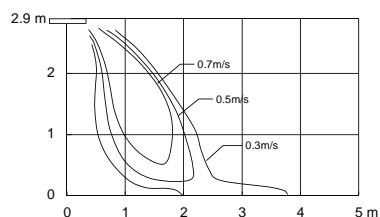

MMU-UP0181MH-E

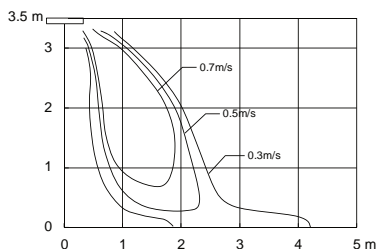

Accessories

No.	Part name	Model name	Applied model	Notes
1	Ceiling panel	RBC-UM21PG(W)-E	MMU-UP_1MH-E	Required accessory
2	Auxiliary fresh air flange	TCB-FF101URE2		For easy fresh air intake by using the knockout hole of indoor unit (dia=100 mm)
3	Wireless remote controller	RBC-AXU31UM-E		For installing on panel
4	Wireless remote controller	RBC-AXU31-E		For installing as stand alone
5	Occupancy sensor	TCB-SIR41UM-E		

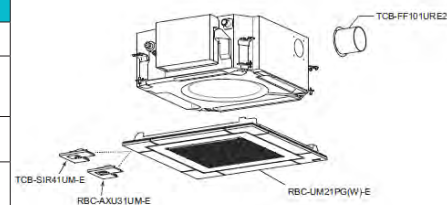

Compact 4-way cassette connectors

* : Available

CN32	CN60	CN61	CN70	CN73	CN80
Additional ventilation control from remote control	Operation status signal output (Cooling, fan, thermo-on)	External On/Off, operation output and alarm output	Warning symbol on remote control based on signal input.	Forced IDU thermo-off based on signal input	Forced IDU thermo-off and IDU lock based on signal input
•	TCB-PCUC2E PCB needed	•	TCB-PCUC2E PCB needed	TCB-PCUC2E PCB needed	TCB-PCUC2E PCB needed



MMU-UP_1WH-E
2-WAY CASSETTE

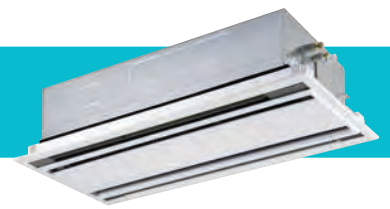

Slim, compact and lightweight, the 2-Way Cassette has been designed to fit easily and discreetly into any room interior.

CAPACITY



0.8 HP - 6 HP

SOUND PRESSURE LEVEL



30 dB(A)

LOCAL CONTROLS



RBC-AXU31UW-E
RBC-AXU31-E



RBC-ASCU11-E
RBC-AMTU31-E
RBC-AMSU51-EN/ES

Features

Model name	MMU-	UP0071WH-E	UP0091WH-E	UP0121WH-E	UP0151WH-E	UP0181WH-E	UP0241WH-E	UP0271WH-E	UP0301WH-E	UP0361WH-E	UP0481WH-E	UP0561WH-E		
Capacity code	HP	0.8	1.0	1.25	1.7	2.0	2.5	3.0	3.2	4.0	5.0	6.0		
Cooling capacity	kW	2.2	2.8	3.6	4.5	5.6	7.1	8.0	9.0	11.2	14.0	16.0		
Electrical characteristics	Power supply	1-phase 230V (220-240V) 50Hz / 1-phase 220V (208-230V) 60Hz												
	Running current (50Hz/60Hz)	A	0.21/0.22		0.21/0.22	0.28/0.29	0.37/0.39		0.43/0.46	0.50/0.53	0.57/0.59	0.77/0.81		
	Power consumption (50Hz/60Hz)	kW	0.024/0.024		0.026/0.026	0.034/0.034	0.045/0.045		0.055/0.055	0.081/0.081	0.091/0.091	0.131/0.131		
	Starting current (50Hz/60Hz)	A	0.31/0.32		0.33/0.35	0.42/0.44	0.57/0.60		0.65/0.68	0.76/0.79	0.85/0.89	1.17/1.22		
Appearance	Main unit	Heat-insulating material attached - Zinc hot dipping steel plate												
	Ceiling panel name	RBC-UW283PG(W)-E				RBC-UW803PG(W)-E				RBC-UW1403PG(W)-E				
	Panel color	Moon white (Munsell 2.5GY9.0/0.5)												
Outer dimensions	Main unit (HxWxD)	mm	295x815x570				345x1180x570				345x1600x570			
	Ceiling panel (HxWxD)	mm	20x1050x680				20x1415x680				20x1835x680			
Total weight	Main unit	kg	18				26				35			
	Ceiling panel	kg	10				14				14			
Heat exchanger	Finned tube													
Soundproof / Heat-insulating material	Non-flammable insulation													
Fan unit	Fan	Turbo fan					Centrifugal fan							
	Standard air flow (H/M/L)	m ³ /h	558/498/450		600/534/450	900/750/618	1050/840/738		1260/900/780	1740/1434/1182	1800/1482/1230	2040/1578/1320		
	Motor output	W	60				94				139			
Sound pressure level (H/M/L)	dB(A)	34/32/30			35/33/30		38/35/33		40/37/34	42/39/36	43/40/37	46/42/39		
Sound power level	dB(A)	49				50		53		55	57	58	61	
Air filter	Standard filter supplied (Long life filter)													
Controller (Optional)	Wired or infrared remote controller													
Connecting pipe	Gas side	mm	9.5	9.5	9.5	12.7	12.7	15.9	15.9	15.9	15.9	15.9		
	Liquid side	mm	6.4	6.4	6.4	6.4	6.4	9.5	9.5	9.5	9.5	9.5		
	Drain port (nominal dia)	mm	25 (Polyvinyl chloride tube)											

Drawings

MMU-UP0071WH-E to MMU-UP0151WH-E

MMU-UP0181WH-E to MMU-UP0301WH-E

Unit : mm

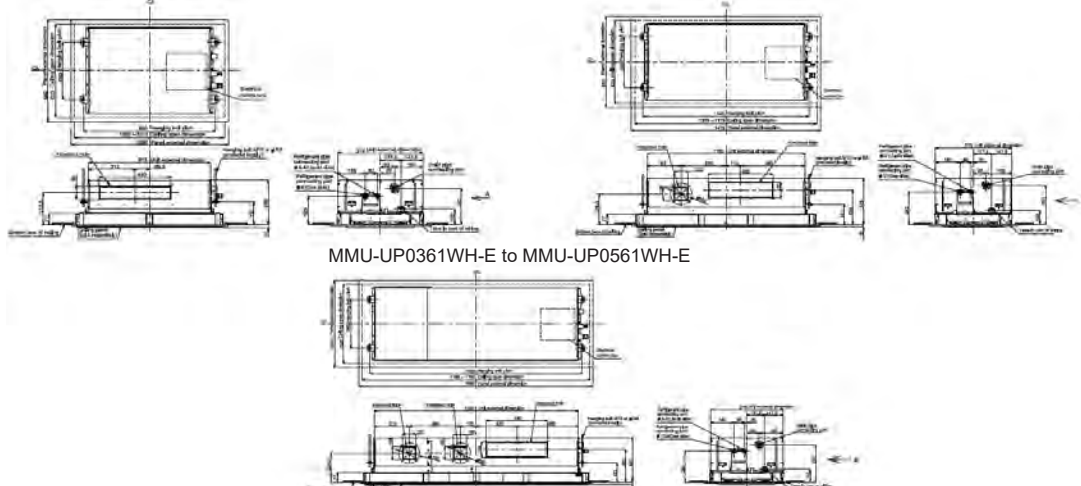

2-WAY CASSETTE

Sound pressure levels

Unit : dB(A)

MMU-UP0071, 0091, 0121WH-E

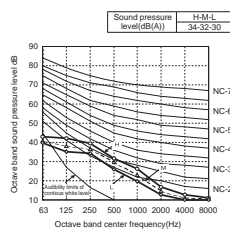

MMU-UP0151WH-E

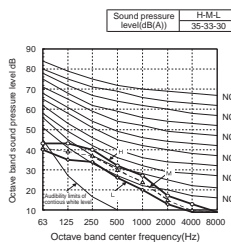

MMU-UP0181WH-E

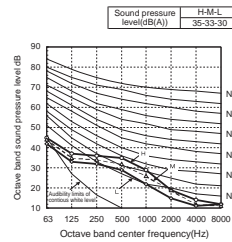

MMU-UP0241, 0271WH-E

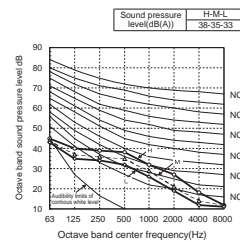

MMU-UP0301WH-E

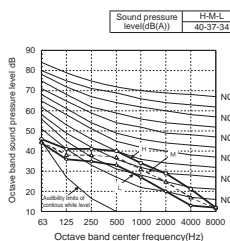

MMU-UP0361WH-E

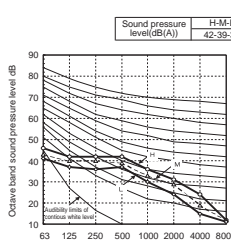

MMU-UP0481WH-E

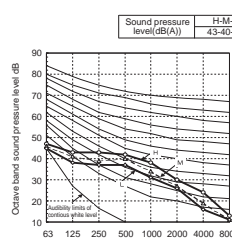

MMU-UP0561WH-E

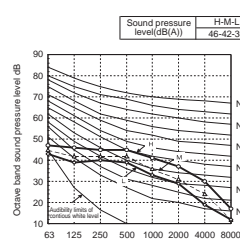

Air diffusion

Unit : m/s

MMU-UP0071, 0091, 0121, 0151WH-E

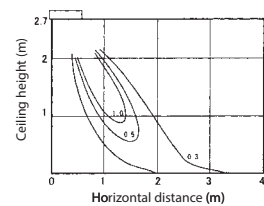

MMU-UP0181WH-E

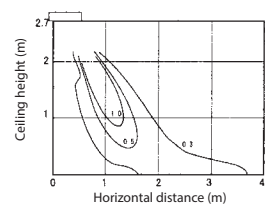

MMU-UP0241, 0271WH-E

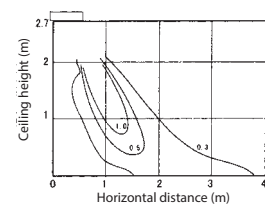

MMU-UP0301WH-E

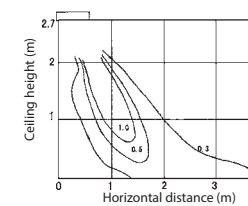

MMU-UP0361, 0481WH-E

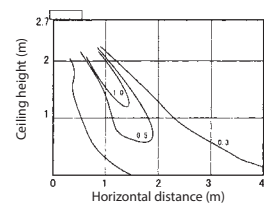

MMU-UP0561WH-E

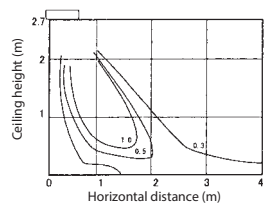

Accessories

No.	Part name	Model name	Applied model	Notes	Remarks
1	Ceiling Panel	RBC-UW283PG(W)-E	MMU-UP0071 to 0151WH-E	Required accessory	
2	Ceiling Panel	RBC-UW803PG(W)-E	MMU-UP0181 to 0301WH-E		
3	Ceiling Panel	RBC-UW1403PG(W)-E	MMU-UP0361 to 0561WH-E		
4	Super long life filter	TBC-LF283UW-E	MMU-UP0071 to 0151WH-E	Dust collecting effect: 50% (Weight method)	Use with TBC-FC283UW-E
5	Super long life filter	TBC-LF803UW-E	MMU-UP0181 to 0301WH-E		Use with TBC-FC803UW-E
6	Super long life filter	TBC-LF1403UW-E	MMU-UP0361 to 0561WH-E		Use with TBC-FC1403UW-E
7	Filter chamber	TBC-FC283UW-E	MMU-UP0071 to 0151WH-E	For super long life filter	
8	Filter chamber	TBC-FC803UW-E	MMU-UP0181 to 0301WH-E		
9	Filter chamber	TBC-FC1403UW-E	MMU-UP0361 to 0561WH-E		
10	Auxiliary fresh air flange	TBC-FF151US-E	MMU-UP0071 to 0561WH-E	For fresh air intake by using the knockout hole of indoor unit.	
11	Wireless remote controller	RBC-AXU31-E	MMU-UP_1WH-E		

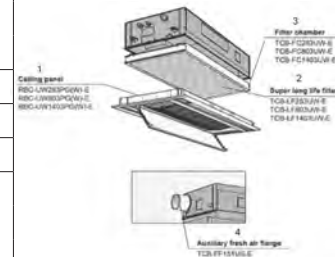

2-way cassette connectors

• : Available

CN32	CN60	CN61	CN70	CN73	CN80
Additional ventilation control from remote control	Operation status signal output (Cooling, fan, thermo-on)	External On/Off, operation output and alarm output	Warning symbol on remote control based on signal input.	Forced IDU thermo-off based on signal input	Forced IDU thermo-off and IDU lock based on signal input
•	•	•	•	•	•

MMU-UP_1YHP-E 1-WAY CASSETTE

> NEW



Toshiba's innovative slim-line 1-Way Cassette is simple to install and suitable for small areas, such as hotels, offices and lobby.

LOCAL CONTROLS



Features

Model name	MMU-	UP0071YHP-E	UP0091YHP-E	UP0121YHP-E	UP0151YHP-E	UP0181YHP-E	UP0241YHP-E	UP0271YHP-E	
Capacity code	HP	0.8	1.0	1.25	1.7	2.0	2.5	3.0	
Cooling capacity	kW	2.2	2.8	3.6	4.5	5.6	7.1	8.0	
Electrical characteristics	Power supply	1-phase 230V (220-240V) 50Hz / 1-phase 220V (208-230V) 60Hz							
	Running current (50Hz/60Hz)	A	0.17/0.18	0.18/0.19	0.19/0.20	0.24/0.25	0.26/0.27	0.34/0.36	0.41/0.43
	Power consumption (50Hz/60Hz)	kW	0.017/0.017	0.018/0.018	0.019/0.019	0.025/0.025	0.027/0.027	0.042/0.042	0.050/0.050
	Starting current (50Hz/60Hz)	A	0.43/0.43	0.43/0.43	0.43/0.43	0.28/0.28	0.30/0.30	0.38/0.38	0.45/0.45
Appearance	Main unit	Heat-insulating material attached - Zinc hot dipping steel plate							
	Ceiling panel name	RBC-UY32P-E				RBC-UY42P-E			
	Panel color	Moon white (Munsell 2.5GY9.0/0.5)							
Outer dimensions	Main unit (HxWxD)	mm	150x990x450				150x1180x450		
	Ceiling panel (HxWxD)	mm	30x1220x530				30x1410x530		
Total weight	Main unit	kg	14				15	16	
	Ceiling panel	kg	4				5		
Heat exchanger		Finned tube							
Soundproof / Heat-insulating material		Non-flammable insulation							
Fan unit	Fan	Centrifugal fan							
	Standard air flow (H/M/L)	m³/h	500/390/270	520/410/290	540/420/290	750/630/500	800/650/500	940/760/600	1000/860/720
	Motor output	W	30			42		59	
Sound pressure level (H/M/L)	dB(A)	38/34/25	39/35/26	40/36/26	39/36/33	40/37/33	46/42/37	47/44/41	
Sound power level	dB(A)	53	54	55					
Air filter		Standard filter supplied (Long life filter) / Air purifier available as option							
Controller (Optional)		Wired or infrared remote controller							
Connecting pipe	Gas side	mm	9.5	9.5	9.5	12.7	12.7	15.9	15.9
	Liquid side	mm	6.4	6.4	6.4	6.4	6.4	9.5	9.5
	Drain port (nominal dia)	mm	25 (Polyvinyl chloride tube)						

Drawings

Unit : mm

MMU-UP0071YHP-E to MMU-UP0121YHP-E

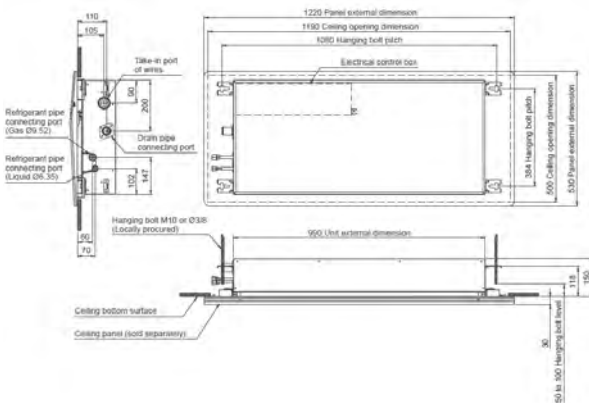

MMU-UP0151YHP-E to MMU-UP0271YHP-E

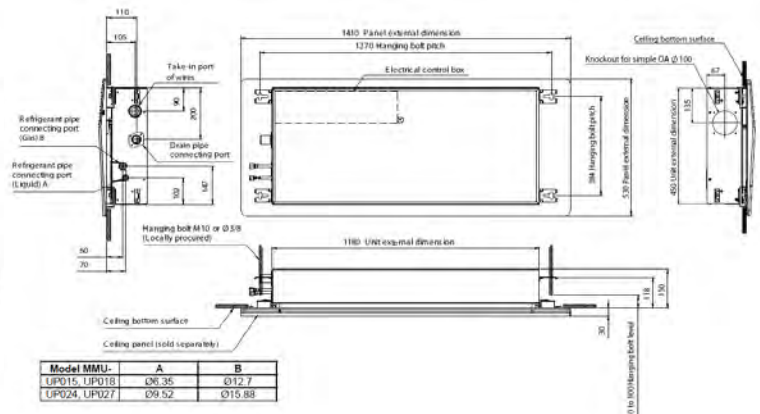

Model	MMU-	A	B
UP015, UP018		Ø6.35	Ø12.7
UP024, UP027		Ø9.52	Ø15.88

1-WAY CASSETTE

Sound pressure levels

Unit : dB(A)

MMU-UP0071YHP-E

Sound pressure level(dB(A)) H-M-L
38-34-25

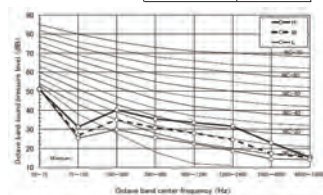

MMU-UP0091YHP-E

Sound pressure level(dB(A)) H-M-L
39-35-26

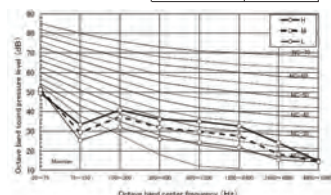

MMU-UP0121YHP-E

Sound pressure level(dB(A)) H-M-L
40-36-26

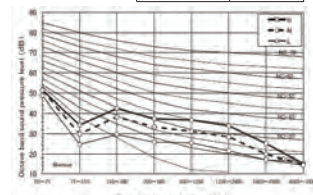

MMU-UP0151YHP-E

Sound pressure level(dB(A)) H-M-L
39-36-33

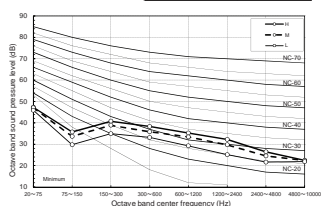

MMU-UP0181YHP-E

Sound pressure level(dB(A)) H-M-L
40-37-33

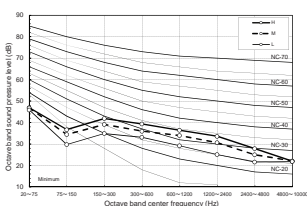

MMU-UP0241YHP-E

Sound pressure level(dB(A)) H-M-L
46-42-37

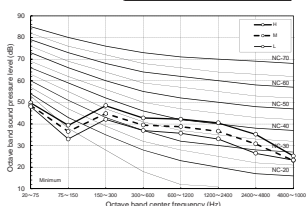

MMU-UP0271YHP-E

Sound pressure level(dB(A)) H-M-L
47-44-41

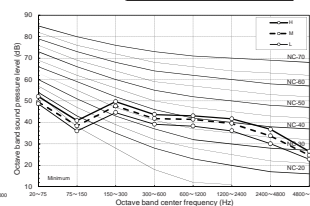

Air diffusion

Unit : m/s

MMU-UP0071YHP-E

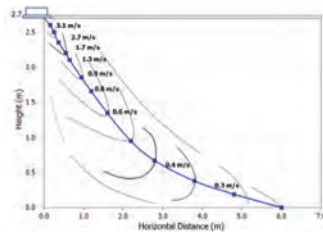

MMU-UP0091YHP-E

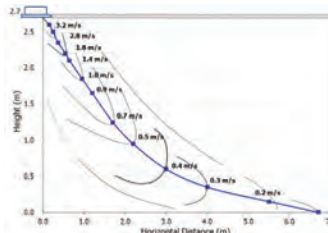

MMU-UP0121YHP-E

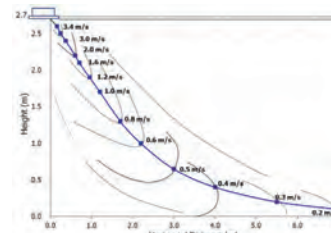

MMU-UP0151YHP-E

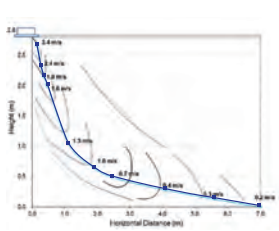

MMU-UP0181YHP-E

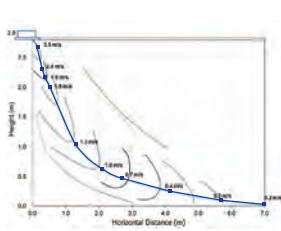

MMU-UP0241YHP-E

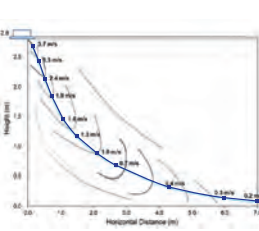

MMU-UP0271YHP-E

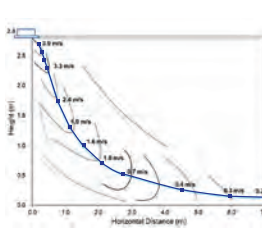

Accessories

No.	Part name	Model name	Applied model	Notes	Remarks
1	Ceiling Panel	RBC-UY32P-E	MMU-UP0071 to 0121YHP-E	Required accessory	
2	Ceiling Panel	RBC-UY42P-E	MMU-UP0151 to 0271YHP-E	Required accessory	
3	Auxiliary fresh air flange	TCB-FF101URE2	MMU-UP0151 to 0271YHP-E	For easy fresh air intake by using the knockout hole of indoor unit. (dia.=100mm)	
4	Air purifier kit	TCB-EAPC1UYHP-E	MMU-UP_1YHP-E		
5	Occupancy sensor	TCB-SIR41UYHP-E			
6	Wireless remote controller	RBC-AX33UYHP-E		For installing on panel	
7	Wireless remote controller	RBC-AXU31-E		For installing as stand alone	

1-way cassette connectors

• : Available

CN32	CN60	CN61	CN70	CN73	CN80
Additional ventilation control from remote control	Operation status signal output (Cooling, fan, thermo-on)	External On/Off, operation output and alarm output	Warning symbol on remote control based on signal input.	Forced IDU thermo-off based on signal input	Forced IDU thermo-off and IDU lock based on signal input
•	TCB-PCUC2E PCB needed	•	TCB-PCUC2E PCB needed	TCB-PCUC2E PCB needed	TCB-PCUC2E PCB needed



MMD-UP_1SPHY-E SLIM DUCT

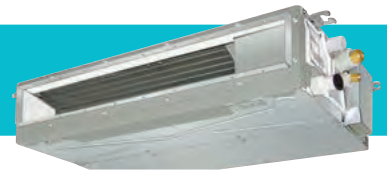

Design for installation in a ceiling void or in a false ceiling, Toshiba Slim Duct offers the ultimate technology, with exceptional energy saving, high performance and easy installation.

CAPACITY



0.8 HP - 3 HP

SOUND PRESSURE LEVEL



26 dB(A)

LOCAL CONTROLS



RBC-AXU31-E



RBC-ASCU11-E
RBC-AMTU31-E
RBC-AMSU51-EN/ES

Features

Model name		MMD-	UP0071SPHY-E	UP0091SPHY-E	UP0121SPHY-E	UP0151SPHY-E	UP0181SPHY-E	UP0241SPHY-E	UP0271SPHY-E	
Cooling code		HP	0.8	1.0	1.25	1.7	2.0	2.5	3.0	
Cooling capacity		kW	2.2	2.8	3.6	4.5	5.6	7.1	8.0	
Electrical characteristics	Power supply	1-phase 50Hz 220-240V / 1-phase 60Hz 208-230V								
	Running current (50Hz/60Hz)	A	0.40/0.42	0.42/0.44	0.44/0.46	0.47/0.49	0.53/0.56	0.69/0.73	0.74/0.78	
	Power consumption (50Hz/60Hz)	kW	0.026/0.026	0.029/0.029	0.031/0.031	0.035/0.035	0.044/0.044	0.067/0.067	0.072/0.072	
	Starting current (50Hz/60Hz)	A	0.69/0.73	0.73/0.77	0.77/0.81	0.82/0.86	0.92/0.97	1.21/1.27	1.30/1.36	
Appearance		Zinc hot dipping steel plate								
Outer dimensions (HxWxD)		mm	210x700x450			210x900x450		210x1110x450		
Total weight		kg	15			19		22		
Heat exchanger		Finned tube								
Soundproof / Heat-insulating material		Polyethylene foam + Polyurethane foam								
Fan unit	Fan	Centrifugal fan (sirocco fan)								
	Standard air flow (H/M/L)	m³/h	540/460/400	570/500/420	600/520/440	690/640/550	780/730/650	1080/950/860	1140/980/910	
	Motor output	W	50			94				
	External static pressure (Factory setting)	Pa	10							
	External static pressure	Pa	10-20-30-40-50 (5 Steps)							
Sound pressure level (H/M/L)	Under air intake	dB(A)	41/39/35	42/40/36	44/40/37	42/39/37	44/42/39	47/44/41	48/45/43	
	Back air intake	dB(A)	31/29/26	32/29/26	33/30/27	33/30/28	34/32/29	36/33/30	37/34/32	
Sound power level		dB(A)	52	54	54	52	56	60	61	
Air filter		Standard filter supplied (Long life filter)								
Controller (Optional)		Wired or infrared remote controller								
Connecting pipe	Gas side	mm	9.5	9.5	9.5	12.7	12.7	15.9	15.9	
	Liquid side	mm	6.4	6.4	6.4	6.4	6.4	9.5	9.5	
	Drain port (nominal dia)	mm	25 (Polyvinyl chloride tube : External dia.32 Internal dia.25)							

Drawings

MMD-UP0071SPHY-E to MMD-UP0271SPHY-E

Unit : mm

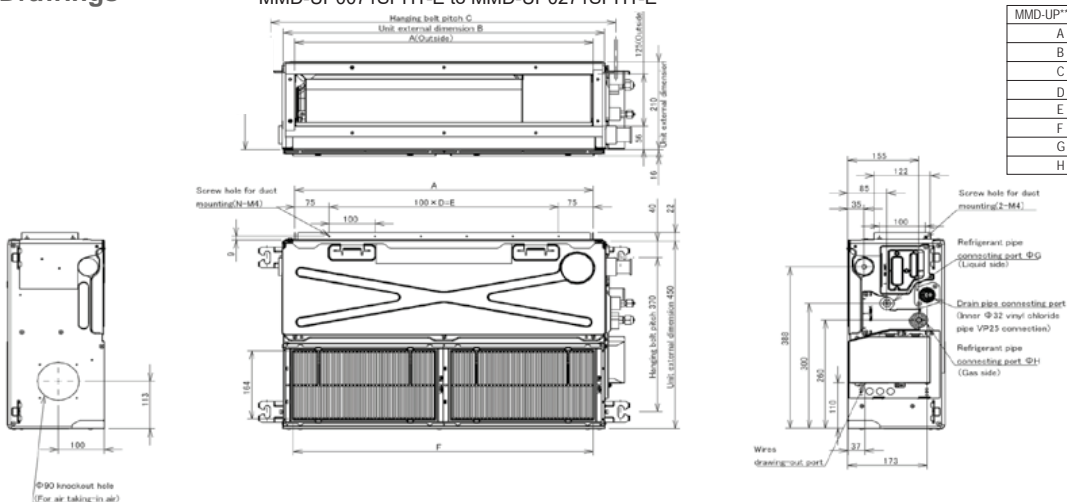

MMD-UP****1SPHY-E	007-012	015-018	024-027
A	650	850	1050
B	700	900	1100
C	770	970	1170
D	5	7	9
E	500	700	900
F	655	855	1055
G		6.4	9.5
H	9.5	12.7	15.9

SLIM DUCT

Sound pressure levels

Unit : dB(A)

MMD-UP0071SPHY-E

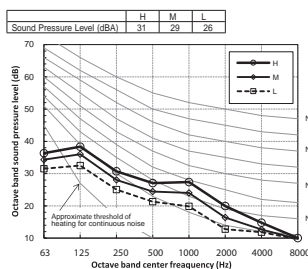

MMD-UP0091SPHY-E

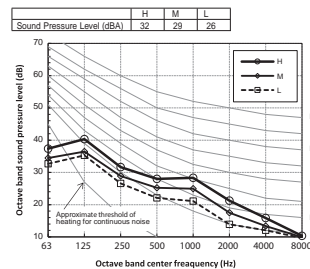

MMD-UP0121SPHY-E

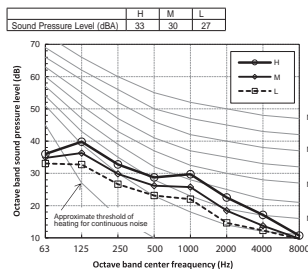

MMD-UP0151SPHY-E

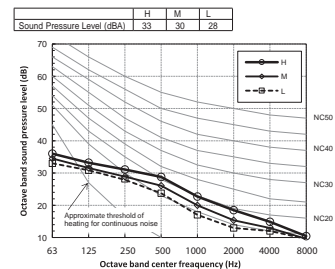

MMD-UP0181SPHY-E

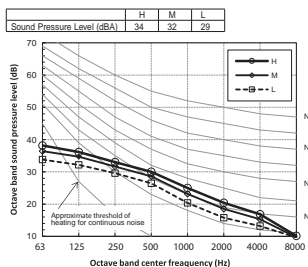

MMD-UP0241SPHY-E

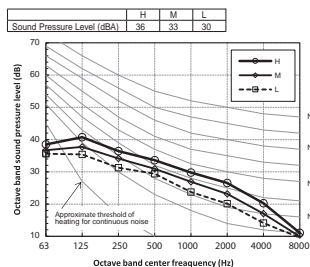

MMD-UP0271SPHY-E

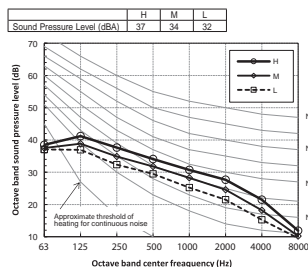

Accessories

No.	Part name	Model name	Applied model	Notes
1	Auxiliary fresh air flange	TCB-FF101URE2	MMD-UP_1SPHY-E	For fresh air intake by using the knockout hole of indoor unit (dia.=100 mm)
2	Wireless remote controller	RBC-AXU31-E		For installing as stand alone

Slim duct connectors

* : Available

CN32	CN60	CN61	CN70	CN73	CN80
Additional ventilation control from remote control	Operation status signal output (Cooling, fan, thermo-on)	External On/Off, operation output and alarm output	Warning symbol on remote control based on signal input.	Forced IDU thermo-off based on signal input	Forced IDU thermo-off and IDU lock based on signal input
•	TCB-PCUC2E PCB needed	•	TCB-PCUC2E PCB needed	TCB-PCUC2E PCB needed	TCB-PCUC2E PCB needed

Installation flexibility

Change from under air intake to back air intake

Under air intake

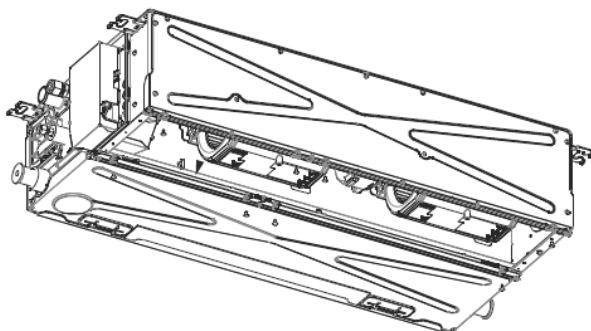

Back air intake

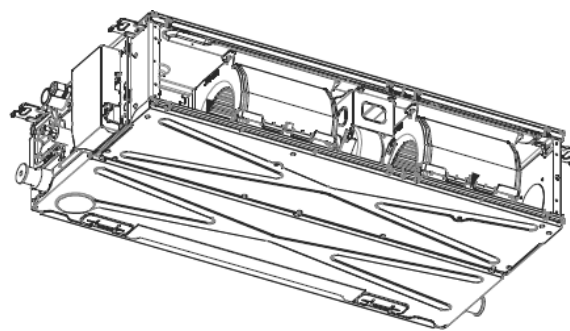



MMD-UP_1BHP-E CONCEALED DUCT

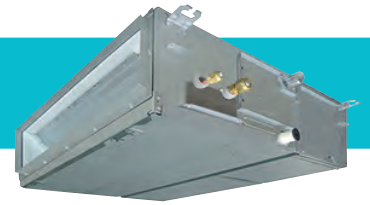

Whatever the shape of the room, this flexible model ensures a uniform temperature and optimal air distribution for end user comfort.

CAPACITY



0.8 HP - 6 HP

SOUND PRESSURE LEVEL



23 dB(A)

LOCAL CONTROLS



RBC-AXU31-E



RBC-ASCU11-E
RBC-AMTU31-E
RBC-AMSU51-ENES

Features

Model name	MMD-	UP0071BHP-E	UP0091BHP-E	UP0121BHP-E	UP0151BHP-E	UP0181BHP-E	UP0241BHP-E	UP0271BHP-E	UP0301BHP-E	UP0361BHP-E	UP0481BHP-E	UP0561BHP-E		
Capacity code	HP	0.8	1.0	1.25	1.7	2.0	2.5	3.0	3.2	4.0	5.0	6.0		
Cooling capacity	kW	2.2	2.8	3.6	4.5	5.6	7.1	8.0	9.0	11.2	14.0	16.0		
Electrical characteristics	Power supply	1-phase 50Hz 220-240V / 1-phase 60Hz 208-230V												
	Running current (50Hz/60Hz)	A	0.35/0.36	0.38/0.40	0.70/0.72	0.80/0.83	0.95/0.98	1.29/1.33	1.70/1.70					
	Power consumption (50Hz/60Hz)	kW	0.055/0.055	0.060/0.060	0.110/0.110	0.135/0.135	0.160/0.160	0.220/0.220	0.290/0.290					
	Starting current (50Hz/60Hz)	A	0.55/0.56	0.58/0.60	1.10/1.12	1.20/1.23	1.35/1.38	2.09/2.13	2.50/2.56					
Appearance	Zinc hot dipping steel plate													
Dimensions (HxWxD)	mm	275x700x750					275x1000x750			275x1400x750				
Total weight	kg	23					30			40				
Heat exchanger	Finned tube													
Soundproof / Heat-insulating material	Polyethylene foam													
Fan unit	Fan	Centrifugal fan												
	Standard air flow (H/M/L)	m³/h	540/450/360	570/480/390	920/660/540	1320/1090/870	1450/1200/960	1920/1620/1380	2350/1920/1500	2350/1090/1500				
	Motor output	W	150					250						
	External static pressure (Factory setting)	Pa	30					40			50			
	External static pressure	Pa	30-40-50-65-80-100-150 (7 Steps)											
Sound pressure level (H/M/L)	dB(A)	29/26/23	30/26/23	30/26/23	33/29/25	33/29/25	33/30/27	33/30/27	36/31/27	36/34/31	40/36/33	40/36/33		
Sound power level	dB(A)	44	45	45	48	48	48	48	51	51	55	55		
Air filter	Standard filter supplied (Long life filter)													
Controller (Optional)	Wired or infrared remote controller													
Connecting pipe	Gas side	mm	9.5	9.5	9.5	12.7	12.7	15.9	15.9	15.9	15.9	15.9		
	Liquid side	mm	6.4	6.4	6.4	6.4	6.4	9.5	9.5	9.5	9.5	9.5		
	Drain port (nominal dia)	mm	25 (Polyvinyl chloride tube)											

Drawings

Unit : mm

MMD-UP0071BHP-E to MMD-UP0181BHP-E

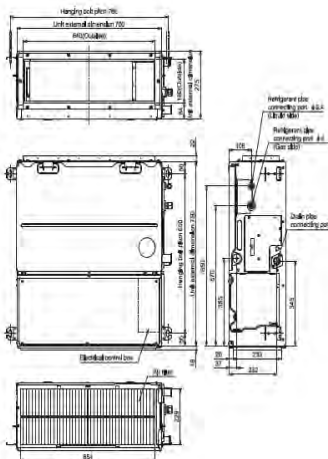

MMD-UP0241BHP-E to MMD-UP0301BHP-E

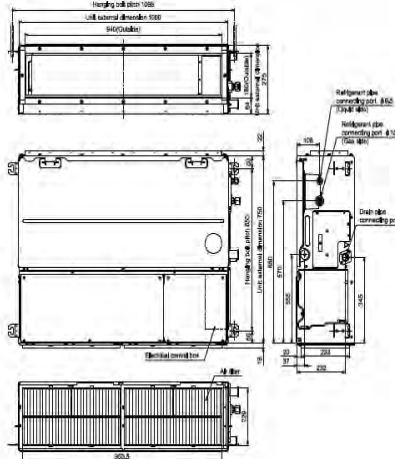

MMD-UP0361BHP-E to MMD-UP0561BHP-E

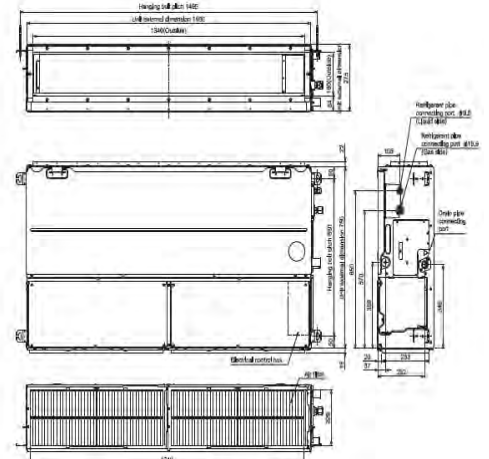

CONCEALED DUCT

Sound pressure levels

Unit : dB(A)

MMD-UP0071BHP-E

External static pressure 80 Pa

FAN tap	H	M	L
Sound pressure level (dB(A))	33	30	27

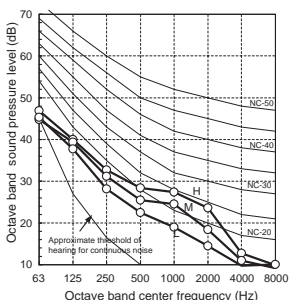

MMD-UP0091, 0121BHP-E

External static pressure 80 Pa

FAN tap	H	M	L
Sound pressure level (dB(A))	34	30	28

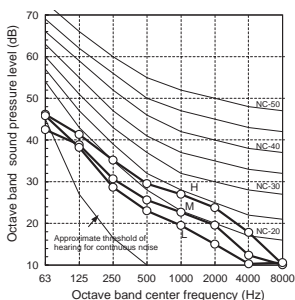

MMD-UP0151, 0181BHP-E

External static pressure 80 Pa

FAN tap	H	M	L
Sound pressure level (dB(A))	37	33	31

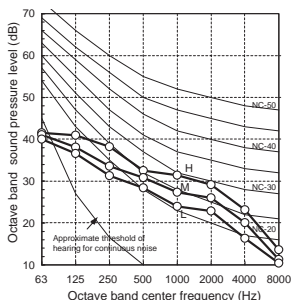

MMD-UP0241, 0271BHP-E

External static pressure 80 Pa

FAN tap	H	M	L
Sound pressure level (dB(A))	42	38	33

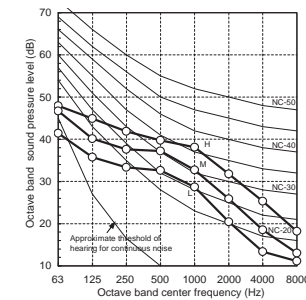

MMD-UP0301BHP-E

External static pressure 80 Pa

FAN tap	H	M	L
Sound pressure level (dB(A))	42	39	33

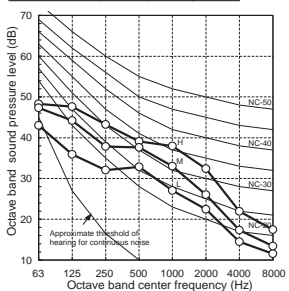

MMD-UP0361BHP-E

External static pressure 80 Pa

FAN tap	H	M	L
Sound pressure level (dB(A))	41	39	35

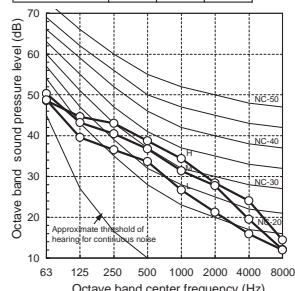

MMD-UP0481, 0561BHP-E

External static pressure 80 Pa

FAN tap	H	M	L
Sound pressure level (dB(A))	41	40	36

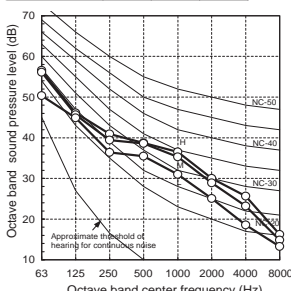

Accessories

No.	Part name	Model name	Applied model	Appearance	Notes
1	Spigot shaped flange	TCB-SF56C6BE	MMD-UP0071 to 0181BHP-E		263x694x175mm / Spigot diameter 200mm
2	Spigot shaped flange	TCB-SF80C6BE	MMD-UP0241 to 0301BHP-E		263x994x175mm / Spigot diameter 200mm
3	Spigot shaped flange	TCB-SF160C6BE	MMD-UP0361 to 0561BHP-E		263x1394x175mm / Spigot diameter 200mm
4	Wireless remote controller	RBC-AXU31-E	MMD-UP_1BHP-E		For installing as stand alone

Concealed duct connectors

• : Available

CN32	CN60	CN61	CN70	CN73	CN80
Additional ventilation control from remote control	Operation status signal output (Cooling, fan, thermo-on)	External On/Off, operation output and alarm output	Warning symbol on remote control based on signal input.	Forced IDU thermo-off based on signal input	Forced IDU thermo-off and IDU lock based on signal input
•	•	•	•	•	•

Installation flexibility

Changing from back air intake to under air intake

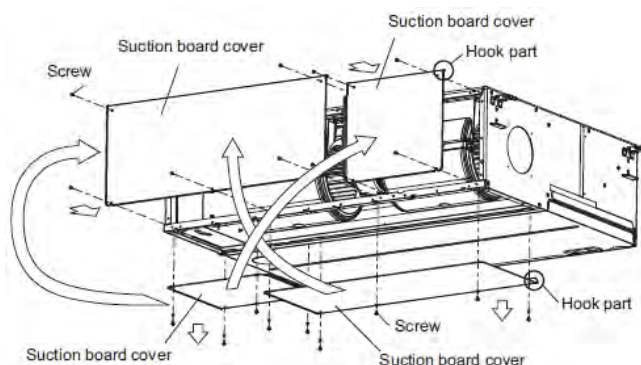

MMD-UP_1HP-E(1) CONCEALED DUCT HIGH STATIC PRESSURE



This is Toshiba's most powerful ducted unit delivering air flows up to 4,800 m³/h with an external static pressure of up to 250 Pa.

CAPACITY



2 HP - 10 HP

SOUND PRESSURE LEVEL



31 dB(A)

LOCAL CONTROLS



RBC-AXU31-E



RBC-ASCU11-E
RBC-AMTU31-E
RBC-AMSU51-EN/ES

Features

Model name	MMD-	UP0181HP-E	UP0241HP-E	UP0271HP-E	UP0361HP-E	UP0481HP-E	UP0561HP-E	UP0721HP-E1	UP0961HP-E1		
Capacity code	HP	2.0	2.5	3.0	4.0	5.0	6.0	8.0	10.0		
Cooling capacity	kW	5.6	7.1	8.0	11.2	14.0	16.0	22.4	28.0		
Electrical characteristics	Power supply	1-phase 50Hz 220-240V / 1-phase 60Hz 208-230V									
	Running current (50Hz/60Hz)	A	0.82/0.85	0.92/0.95	1.16/1.20	1.39/1.43	1.81/1.86	2.48/2.57	2.83/2.93	3.77/3.92	
	Power consumption (50Hz/60Hz)	kW	0.125/0.125	0.140/0.140	0.190/0.190	0.230/0.230	0.300/0.300	0.400/0.400	0.540/0.540	0.790/0.790	
	Starting current (50Hz/60Hz)	A	1.12/1.15	1.22/1.25	1.46/1.50	1.89/1.93	2.41/2.46	3.08/3.17	7.80/8.15	7.80/8.15	
Appearance	Zinc hot dipping steel plate										
Dimensions (HxWxD)	mm	298x1000x750			298x1400x750			448x1400x900			
Total weight	kg	34			43			97			
Heat exchanger	Finned tube										
Soundproof / Heat-insulating material	Polyethylene foam										
Fan unit	Fan	Centrifugal fan									
	Standard air flow (H/M/L)	m ³ /h	1100/990/900	1200/1050/960	1500/1350/1200	1920/1560/1340	2340/1980/1695	2760/2340/1920	3800/3200/2500	4800/4200/3500	
	Motor output	W	250			350			1000		
	External static pressure (Factory setting)	Pa	100						150		
External static pressure	Pa	50-75-125-100-150-175-200 (7steps)						50-83-117-150-183-217-250 (7steps)			
Sound pressure level (H/M/L)	dB(A)	37/33/31	38/34/31	43/41/38	41/37/34	44/44/38	46/44/41	44/40/36	46/42/38		
Sound power level	dB(A)	60			62	67	69	79	81		
Air filter	Sold separately (TCB-LK801D-E)			Sold separately (TCB-LK1401D-E)			Sold separately (TCB-LK2801DP-E)				
Controller (Optional)	Wired or infrared remote controller										
Connecting pipe	Gas side	mm	12.7	15.9	15.9	15.9	15.9	15.9	22.2	22.2	
	Liquid side	mm	6.4	9.5	9.5	9.5	9.5	9.5	12.7	12.7	
	Drain port (nominal dia)	mm	25 (Polyvinyl chloride tube)								

Drawings

Unit : mm

MMD-UP0181HP-E to MMD-UP0561HP-E

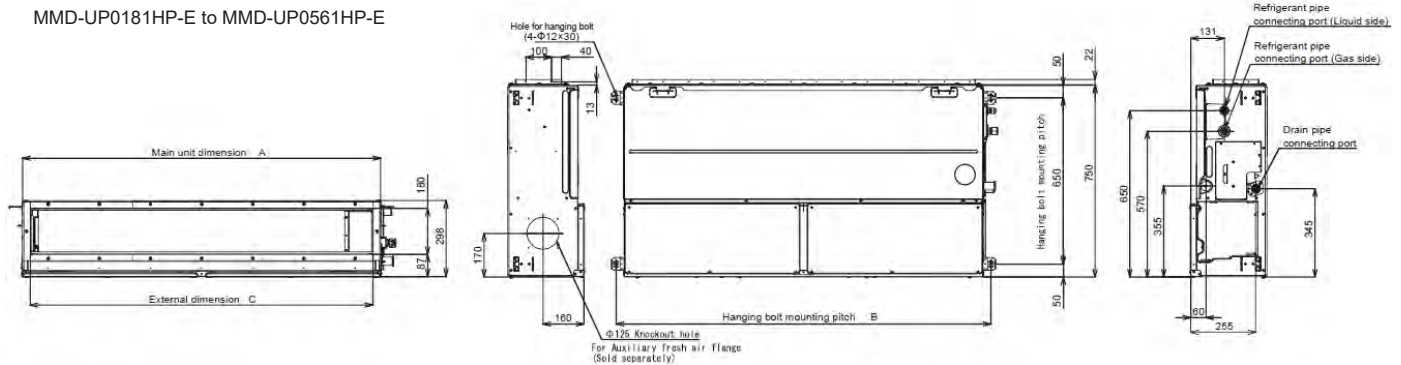

Dimension

	A	B	C	D
AP018-027 type	1000	1065	940	500
AP036-056 type	1400	1465	1340	700

CONCEALED DUCT HIGH STATIC PRESSURE

Drawings

MMD-UP0721HP-E1 & MMD-UP0961HP-E1

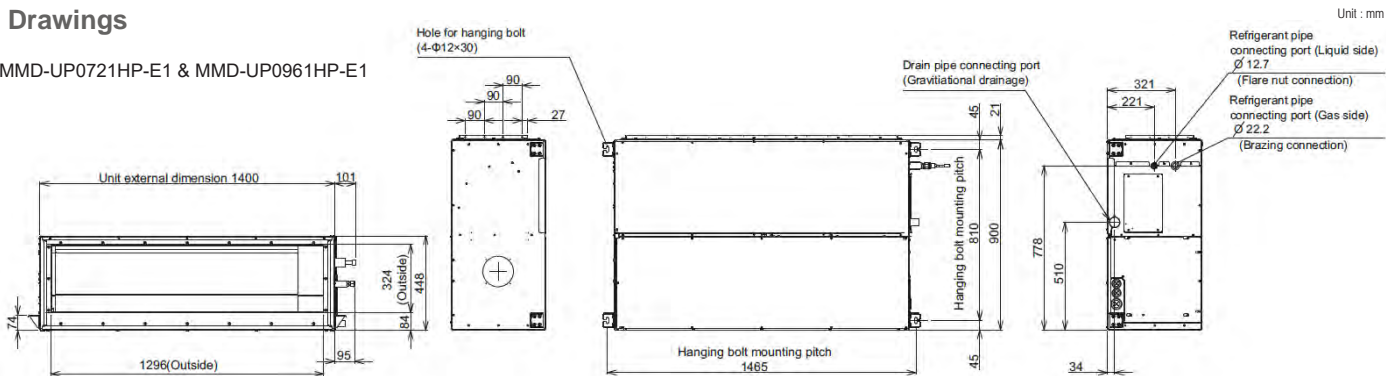

Sound pressure levels

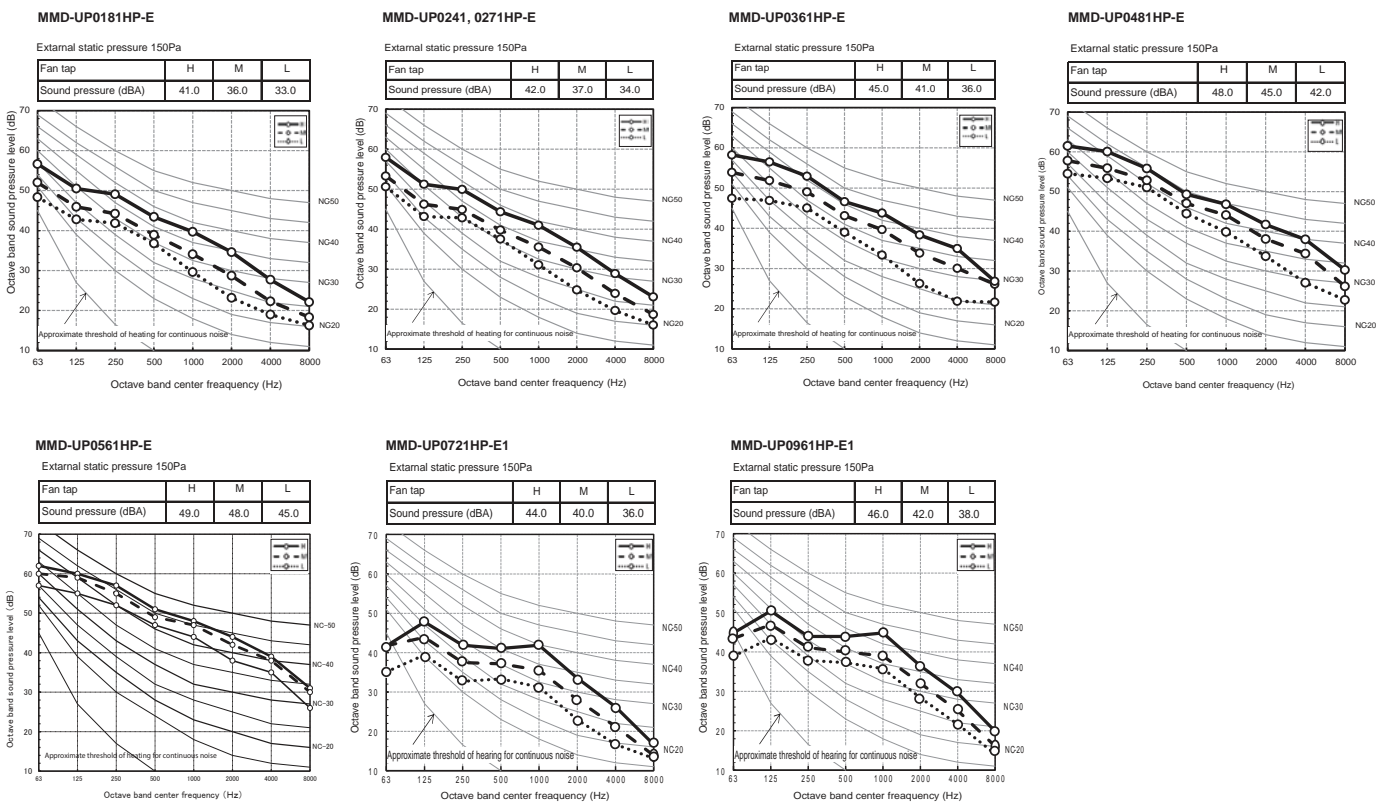

Accessories

No.	Part name	Model name	Applied model	Appearance	Notes
1	Spigot shaped flange	TCB-SF80C6BE	MMD-UP0181 to 0271HP-E		263x994x175mm / Spigot diameter 200mm
2	Spigot shaped flange	TCB-SF160C6BE	MMD-UP0361 to 0561HP-E		263x1394x175mm / Spigot diameter 200mm
3	Long life filter kit	TCB-LK801D-E	MMD-UP0181 to 0271HP-E		Flange shaped Mount chassis directly Upside down mounting possible Left and right removable
4	Long life filter kit	TCB-LK1401D-E	MMD-UP0361 to 0561HP-E		
5	Long life filter kit	TCB-LK2801DP-E	MMD-UP0721 to 0961HP-E1		
6	Auxiliary fresh air flange	TCB-FF151US-E	MMD-UP0181 to 0561HP-E		
7	Drain pump kit	TCB-DP40DPE	MMD-UP0721 to 0961HP-E1		
8	Wireless remote controller	RBC-AXU31-E	MMD-UP_1HP-E		For installing as stand alone

Concealed duct high static pressure connectors

• : Available

	CN32	CN60	CN61	CN70	CN73	CN80
	Additional ventilation control from remote control	Operation status signal output (Cooling, fan, thermo-on)	External On/Off, operation output and alarm output	Warning symbol on remote control based on signal input.	Forced IDU thermo-off based on signal input	Forced IDU thermo-off and IDU lock based on signal input
Up to 6HP	•	•	•	•	•	•
8 & 10HP	•	TCB-PCUC2E PCB needed	•	TCB-PCUC2E PCB needed	TCB-PCUC2E PCB needed	TCB-PCUC2E PCB needed

FRESH AIR INTAKE

MMD-UP_1HFP-E(1) FRESH AIR INTAKE



This indoor unit has been specifically designed to manage and treat fresh air before its distribution into the building.

CAPACITY



5 HP - 14 HP

AIR FLOW



Up to 1,080m³/h - 3,060m³/h

SOUND PRESSURE LEVEL



31 dB(A)

LOCAL CONTROLS



RBC-AXU31-E



RBC-ASCU11-E
RBC-AMTU31-E
RBC-AMSU51-ENES

Features

Model name	MMD-	UP0481HFP-E	UP0721HFP-E1	UP0961HFP-E1	UP1121HFP-E1	UP1281HFP-E1	
Cooling code	HP	5.0	8.0	10.0	12.0	14.0	
Cooling capacity (*) (Note 1)	kW	14.0	22.4	28.0	33.5	40.0	
Electrical characteristics	Power supply	1-phase 50Hz 220-240V / 1-phase 60Hz 208-230V					
	Running current (50Hz/60Hz)	A	0.77/0.80	0.86/0.90	1.07/1.12	1.30/1.36	1.83/1.91
	Power consumption (50Hz/60Hz)	kW	0.108/0.108	0.153/0.153	0.198/0.198	0.240/0.240	0.330/0.330
	Starting current (50Hz/60Hz)	A	2.01/2.10	7.80/8.15	7.80/8.15	7.80/8.15	7.80/8.15
Dimensions (HxWxD)	mm	327x1430x750	477x1430x900				
Total weight	kg	44	99				
Heat exchanger	Finned tube						
Soundproof / Heat-insulating material	Non-flammable insulation						
Fan unit	Fan	Centrifugal fan					
	Standard air flow (H/M/L)	m ³ /h	1080/930/760	1680/1440/1200	2100/1800/1470	2520/2130/1770	3060/2580/2130
	Motor output	W	350	1000			
	External static pressure (Factory setting)	Pa	100				
	External static pressure	Pa	50-75-100-125-150-175-200 (7 Steps)				
	Air flow limit	Lower limit	m ³ /h	600	960	1320	1500
Upper limit		m ³ /h	1320	2040	2520	3060	3600
Sound pressure level (H/M/L)	dB(A)	38/35/31	38/36/33	39/36/33	40/37/34	42/38/35	
Air filter	Option or field supply						
Controller (Optional)	Wired or infrared remote controller						
Connecting pipe	Gas / Liquid side	mm	15.9 / 9.5	22.2 / 12.7	28.6 / 12.7	28.6 / 12.7	
	Drain port (nominal dia)	mm	25 (Polyvinyl chloride tube)				

* The setting temperature is 13 - 25°C (standard IDU 18 - 30 °C).

Note 1 : Rated conditions
Cooling : Outdoor air temperature 33°C DB/28°C WB setting temperature 18°C
Note 2 : When supply air temperature is *setting temperature + 3°C or less, Fresh Air Intake unit operates as FAN mode
Note 3 : When supply air temperature is *setting temperature -3°C or over, Fresh Air Intake unit operates as FAN mode
Note 4 : 46-52°C is also available but temporary operate

Use conditions

• In "COOL" or "FAN" mode, if temperature of the outdoor/suction air is under 5°C, the operation stops automatically in order to protect the equipment.

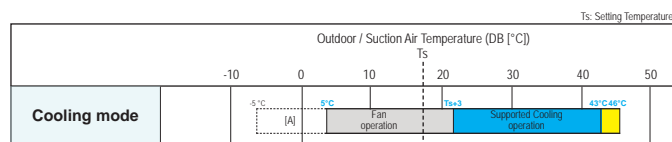

Drawings

MMD-UP0481HFP-E

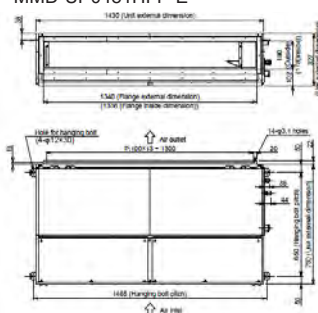

MMD-UP0721HFP-E1 to MMD-UP1281HFP-E1

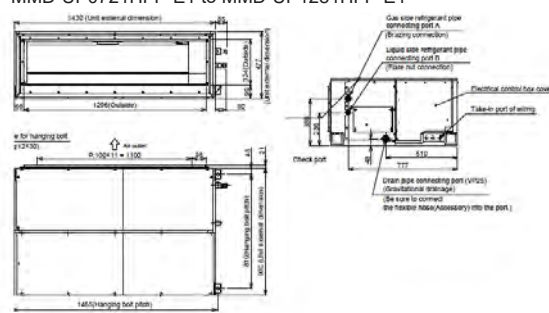

Unit : mm

FRESH AIR INTAKE

Fresh air intake indoor unit type

System restriction	SMMS-7	SMMS-7	SMMS-∞	SMMS-∞			
	Multi IDU connection	All fresh air intake connection	Multi IDU connection	All fresh air intake connection			
Max. no. of combined outdoor units	3	1	5	2			
Max. capacity of combined outdoor units	60HP	24HP	120HP	52HP			
Maximum number of connected indoor units	64	3	128	4			
Total capacity of combined Indoor+fresh air unit	80 to 110%	100%	80 to 110%				
Max. no. of combined Indoor units	3		4				
Allowable length and height difference of refrigerant piping	Allowable value (m)						
	SMMS-7 Multi IDU connection	SMMS-7 All fresh air intake connection	SMMS-∞ Multi IDU connection	SMMS-∞ All fresh air intake connection			
Pipe length	Total extension of pipe (Liquid pipe)	Actual length	m	300/1000	300	500/1200	300
	Farthest piping length	Equivalent / Actual length	m	235/190	150/130	250/210	230/210
	Main piping length	Equivalent / Actual length	m	120/100	120/100	120/100	120/100
	Farthest equivalent piping length from the first branching section	Equivalent length	m	90/65	30	90	90
	Maximum actual length of pipes connected to indoor units	Actual length	m	30	30	30	30
	Maximum equivalent length between branching sections	Equivalent length	m	50	50	50	50
Height difference	Height between outdoor and indoor units	Upper / Lower outdoor unit	m	70/40	40/3	70/40	70/40
	Height between indoor units /fresh air intake units		m	0.5	0.5	40	5

Sound pressure levels

Unit : dB(A)

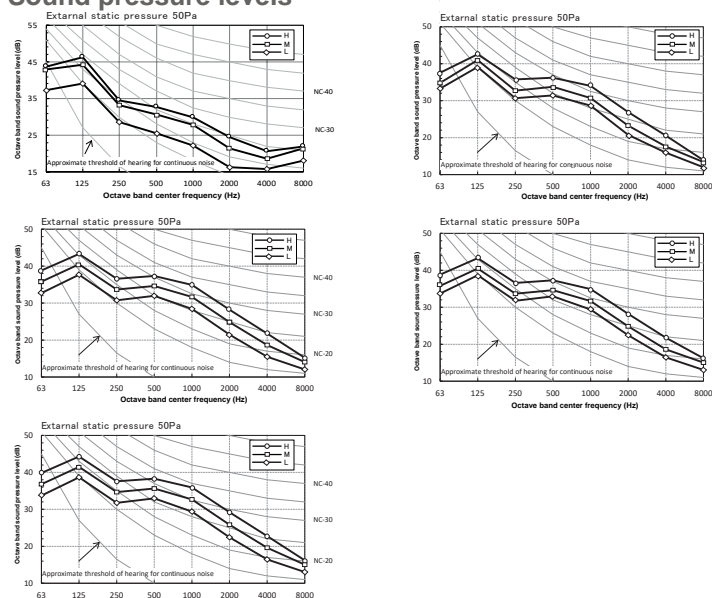

Other information

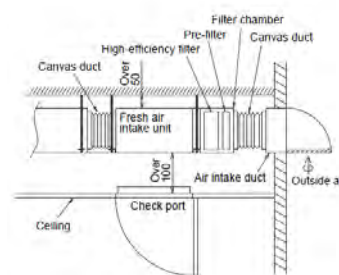

Accessories

No.	Part name	Model name	Applied model	Appearance	Notes
1	High-efficiency filter 65	TCB-UFM0481D-E	MMD-UP0481HFP-E		
2	High-efficiency filter 65	TCB-UFM1281D-E	MMD-UP0721 to 1281HFP-E		
3	High-efficiency filter 90	TCB-UFH0481D-E	MMD-UP0481HFP-E		
4	High-efficiency filter 90	TCB-UFH1281D-E	MMD-UP0721 to 1281HFP-E		
5	Stand alone long life prefilter	TCK-LK1401D-E	MMD-UP0481HFP-E		
6	Stand alone long life prefilter	TCK-LK2801DP-E	MMD-UP0721 to 1281HFP-E		
7	High efficiency long life prefilter	TCK-LK1401D-E (*2)	MMD-UP0481HFP-E		
8	High efficiency long life prefilter	TCK-PF1281DF-E	MMD-UP0721 to 1281HFP-E		
9	Filter chamber	TCB-FC0481DF-E	MMD-UP0481HFP-E		
10	Filter chamber	TCB-FC1281DF-E	MMD-UP0721 to 1281HFP-E		
11	Drain pump kit	TCB-DP40DFP-E	All models		
12	Wireless remote controller	RBC-AXU31-E	MMD-UP_1HFP-E		

Fresh air intake connectors

* : Available

	CN32	CN60	CN61	CN70	CN73	CN80
	Additional ventilation control from remote control	Operation status signal output (Cooling, fan, thermo-on)	External On/Off, operation output and alarm output	Warning symbol on remote control based on signal input.	Forced IDU thermo-off based on signal input	Forced IDU thermo-off and IDU lock based on signal input
5HP	•	•	•	•	•	•
8 & 14HP	•	TCB-PCUC2E PCB needed	•	TCB-PCUC2E PCB needed	TCB-PCUC2E PCB needed	TCB-PCUC2E PCB needed



MMC-UP_1HP-E CEILING



Simple, yet elegant design helps to create a pleasant and relaxing environment, quickly conditioning the room air to the desired temperature.

CAPACITY



1.7 HP - 6 HP

SOUND PRESSURE LEVEL



28 dB(A)

LOCAL CONTROLS



Features

Model name	MMC-	UP0151HP-E	UP0181HP-E	UP0241HP-E	UP0271HP-E	UP0361HP-E	UP0481HP-E	UP0561HP-E	
Capacity code	HP	1.7	2.0	2.5	3.0	4.0	5.0	6.0	
Cooling capacity	kW	4.5	5.6	7.1	8.0	11.2	14.0	16.0	
Electrical characteristics	Power supply	1 phase 50Hz 230V (220-240V) / 1 phase 60Hz 220V							
	Running current (50Hz/60Hz)	A	0.35/0.37	0.36/0.38	0.64/0.67	0.65/0.67	0.77/0.80	0.77/0.80	0.99/1.02
	Power consumption (50Hz/60Hz)	kW	0.033/0.033	0.034/0.034	0.067/0.067	0.067/0.067	0.083/0.083	0.083/0.083	0.111/0.111
	Starting current (50Hz/60Hz)	A	0.54/0.55	0.55/0.57	0.96/1.00	0.97/1.00	1.15/1.20	1.15/1.20	1.49/1.43
Appearance		Pure White (Munsell N9.1)							
Dimensions (HxWxD)	mm	235x950x690			235x1270x690		235x1586x690		
Total weight	kg	24			30		39		
Heat exchanger		Finned tube							
Soundproof / Heat-insulating material		Polyethylene foam							
Fan unit	Fan	Centrifugal fan (Sirocco fan)							
	Standard air flow (H/M/L)	m³/h	840/690/540	960/720/540	1440/1020/750	1440/1020/750	1860/1350/1020	1860/1530/1200	2040/1650/1260
	Motor output	W	94				139		
Sound pressure level (H/M/L)	dB(A)	36/34/28	37/35/28	41/36/29	41/36/29	44/38/32	44/41/35	46/42/36	
Sound power level	dB(A)	51	52	56	56	59	59	61	
Air filter		Standard filter supplied (Long life filter)							
Controller (Optional)		Wired or infrared remote controller							
Connecting pipe	Gas side	mm	12.7	12.7	15.9	15.9	15.9	15.9	15.9
	Liquid side	mm	6.4	6.4	9.5	9.5	9.5	9.5	9.5
	Drain port (nominal dia)	mm	20 (Polyvinyl chloride tube)						

Drawings

Unit : mm

MMC-UP0151HP-E, MMC-UP0181HP-E

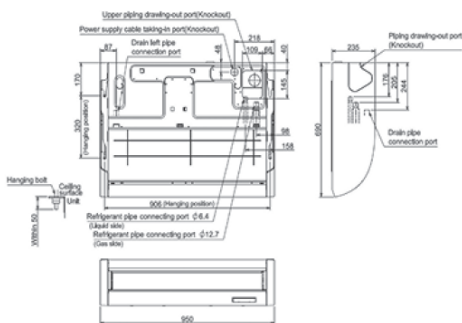

MMC-UP0241HP-E, MMC-UP0271HP-E

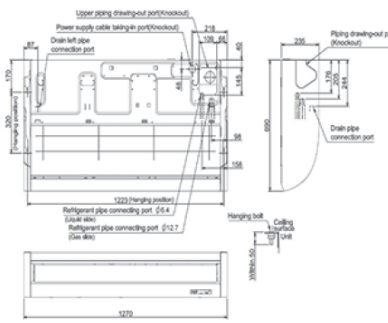

MMC-UP0361HP-E to MMC-UP0561HP-E

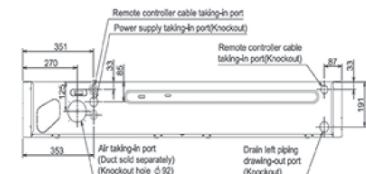
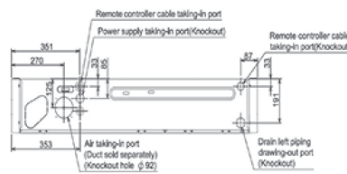
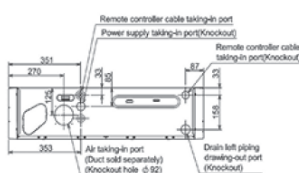
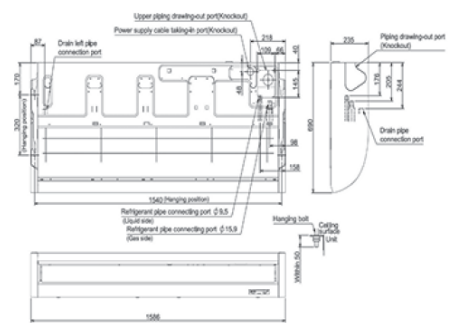

CEILING

Sound pressure levels

Unit : dB(A)

MMC-UP0151HP-E

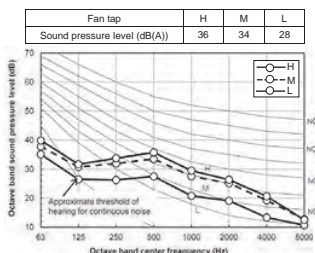

MMC-UP0181HP-E

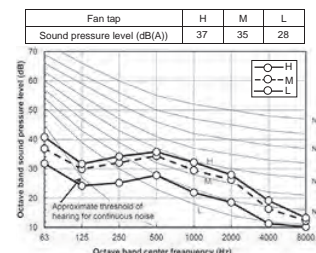

MMC-UP0241, 0271HP-E

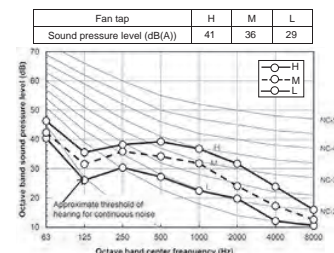

MMC-UP0361HP-E

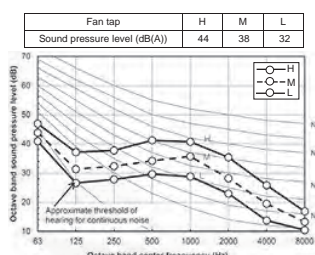

MMC-UP0481HP-E

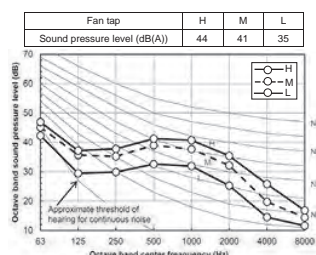

MMC-UP0561HP-E

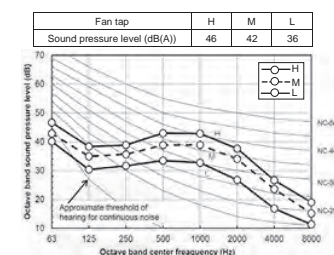

Air diffusion

Unit : m/s

MMC-UP0151HP-E

Cooling

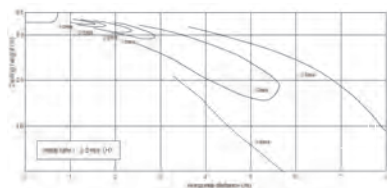

MMC-UP0181HP-E

Cooling

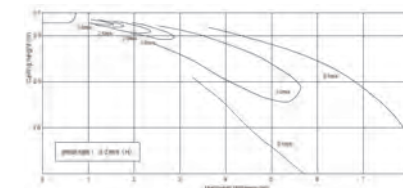

MMC-UP0241, 0271HP-E

Cooling

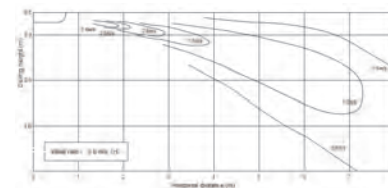

MMC-UP0361, 0481HP-E

Cooling

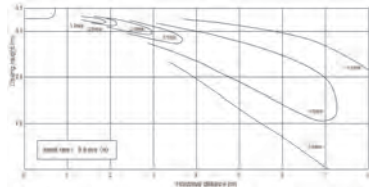

MMC-UP0561HP-E

Cooling

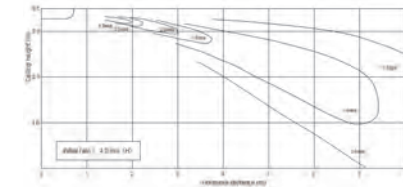

Accessories

No.	Part name	Model name	Applied model	Notes	Remarks
1	Wireless Remote Controller kit	RBC-AXU31C-E	MMC-UP_1HP-E	For installing as stand alone	
2	Wireless Remote Controller	RBC-AXU31-E			
3	Drain pump kit	TCB-DP31CE		Antibacterial glass is built into drain pump kit	
4	Elbow piping kit	TCB-KP14CPE	MMC-UP0151 to 0181HP-E	It is necessary for installation of drain pump kit	Use with TCB-DP31CE
5	Elbow piping kit	TCB-KP24CPE	MMC-UP0241 to 0561HP-E		
6	Option connecting kit	TCB-PCUC2E	MMC-UP_1HP-E	For external I/O signal without local relay preparation	

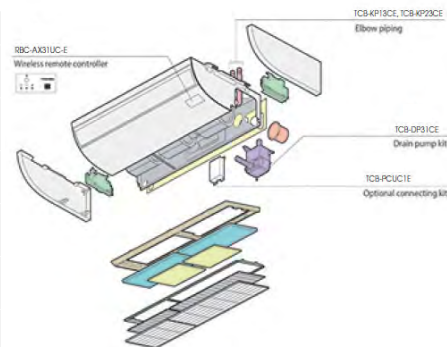

Ceiling connectors

* : Available

CN32	CN60	CN61	CN70	CN73	CN80
Additional ventilation control from remote control	Operation status signal output (Cooling, fan, thermo-on)	External On/Off, operation output and alarm output	Warning symbol on remote control based on signal input.	Forced IDU thermo-off based on signal input	Forced IDU thermo-off and IDU lock based on signal input
•	TCB-PCUC2E PCB needed	•	TCB-PCUC2E PCB needed	TCB-PCUC2E PCB needed	TCB-PCUC2E PCB needed

MMK-UP_1HP-E
HIGH-WALL

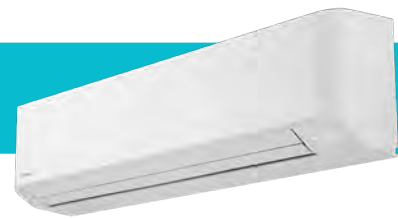

Particularly compact, this high-wall is perfect for limited spaces, such as offices or small shops.

LOCAL CONTROLS



Included



RBC-ASCU11-E
RBC-AMTU31-E
RBC-AMSU51-EN/ES

CAPACITY



0.8 HP - 4 HP

SOUND PRESSURE LEVEL



25 dB(A)

Features

Model name	MMK-	UP0071HP-E	UP0091HP-E	UP0121HP-E	UP0151HP-E	UP0181HP-E	UP0241HP-E	UP0271HP-E	UP0301HP-E	UP0361HP-E	
Cooling code	HP	0.8	1.0	1.25	1.7	2.0	2.5	3.0	3.2	4.0	
Cooling capacity	kW	2.2	2.8	3.6	4.5	5.6	7.1	8.0	9.0	11.2	
Electrical characteristics	Power supply	1 phase 50Hz 230V (220-240V) / 1 phase 60Hz 220V									
	Running current (50Hz/60Hz)	A	0.15/0.16	0.16/0.17	0.17/0.18	0.25/0.26	0.28/0.29	0.40/0.42	0.28/0.30	0.44/0.46	0.52/0.56
	Power consumption (50Hz/60Hz)	kW	0.015/0.015	0.016/0.016	0.017/0.017	0.028/0.028	0.032/0.032	0.050/0.050	0.034/0.034	0.054/0.054	0.066/0.066
	Starting current (50Hz/60Hz)	A	0.19/0.20	0.20/0.21	0.21/0.22	0.33/0.35	0.36/0.38	0.48/0.50	0.34/0.34	0.50/0.50	0.60/0.60
Dimensions (HxWxD)	mm	293x798x230			320x1050x250			348x1200x280			
Total weight	kg	11			16			21			
Heat exchanger		Finned tube									
Soundproof / Heat-insulating material		Non-flammable insulation									
Fan unit	Fan	Cross Flow Fan									
	Standard air flow (H/M/L)	m ³ /h	480/385/270	510/395/270	540/410/270	840/690/550	900/720/550	1200/900/600	1200/1000/800	1500/1300/1100	1650/1350/1250
Sound pressure level (H/M/L)	dB(A)	35/30/25	36/31/25	37/32/25	40/36/32	41/37/32	45/39/33	44/41/39	48/44/41	50/45/43	
Sound power level	dB(A)	50	51	52	55	56	60	60	63	65	
Air filter		Standard filter supplied (Long life filter)									
Controller (Packed with unit)		Wireless remote controller									
Connecting pipe	Gas side	mm	12.7	12.7	12.7	12.7	12.7	15.9	15.9	15.9	15.9
	Liquid side	mm	6.4	6.4	6.4	6.4	6.4	9.5	9.5	9.5	9.5
	Drain port (nominal dia)	mm	16 (Polyvinyl chloride tube)								

Drawings

Unit : mm

MMK-UP0071HP-E to MMK-UP0121HP-E

MMK-UP0151HP-E to MMK-UP0241HP-E

MMK-UP0271HP-E to MMK-UP0361HP-E

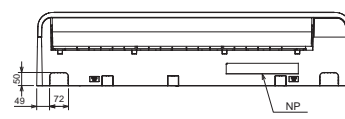
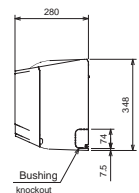
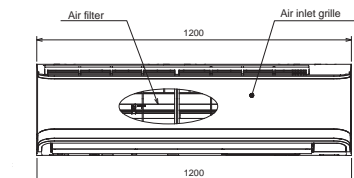
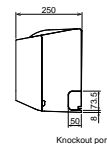
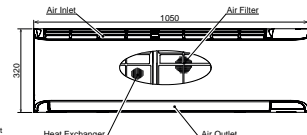
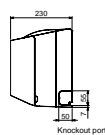
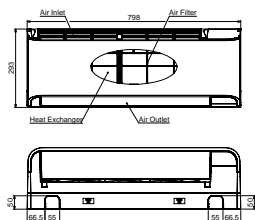

HIGH-WALL

Sound pressure levels

Unit : dB(A)

MMK-UP0071HP-E

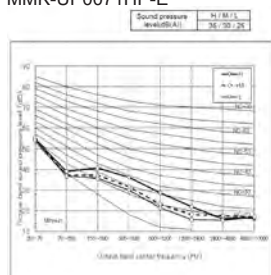

MMK-UP0091HP-E

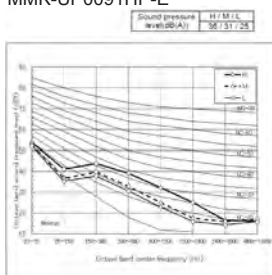

MMK-UP0121HP-E

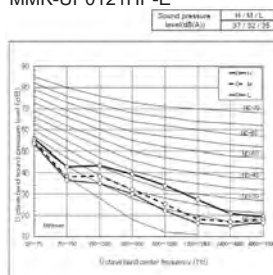

MMK-UP0151HP-E

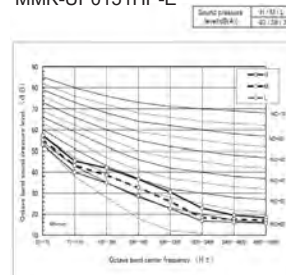

MMK-UP0181HP-E

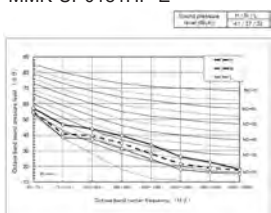

MMK-UP0241HP-E

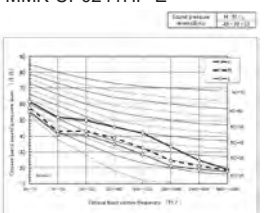

MMK-UP0271HP-E

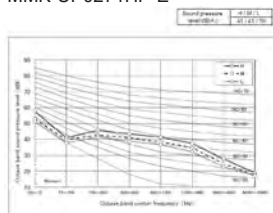

MMK-UP0301HP-E

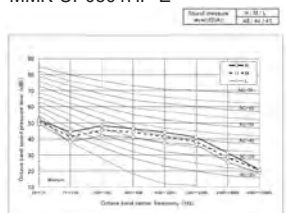

MMK-UP0361HP-E

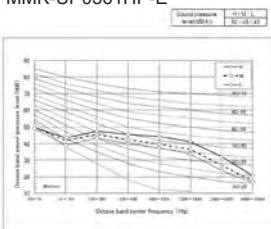

Air diffusion

Unit : m/s

MMK-UP0071HP-E

High wind: 3.9m/s
Mid wind: 3.0m/s
Low wind: 2.5m/s

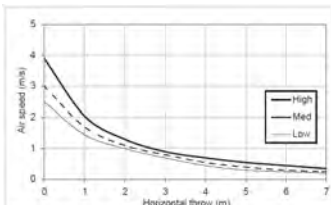

MMK-UP0091HP-E

High wind: 4.1m/s
Mid wind: 3.2m/s
Low wind: 2.5m/s

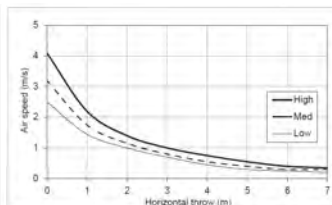

MMK-UP0121HP-E

High wind: 4.3m/s
Mid wind: 3.4m/s
Low wind: 2.5m/s

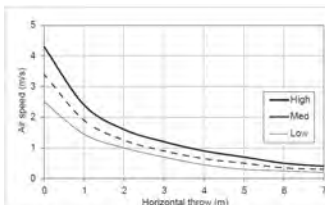

MMK-UP0151HP-E

High wind: 4.6m/s
Mid wind: 3.7m/s
Low wind: 2.8m/s

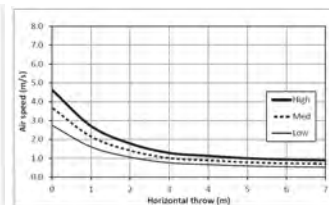

MMK-UP0181HP-E

High wind: 5.0m/s
Mid wind: 3.9m/s
Low wind: 2.8m/s

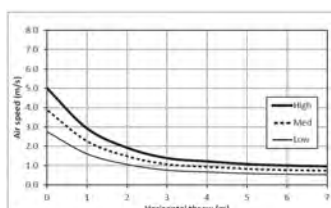

MMK-UP0241HP-E

High wind: 6.5m/s
Mid wind: 5.0m/s
Low wind: 3.1m/s

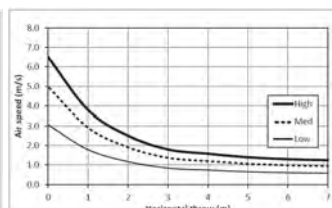

MMK-UP0271HP-E

High wind: 6.5m/s
Mid wind: 5.2m/s
Low wind: 3.6m/s

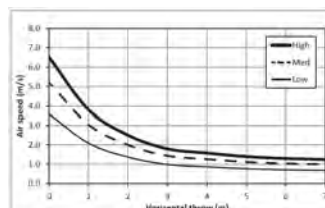

MMK-UP0301HP-E

High wind: 7.5m/s
Mid wind: 6.6m/s
Low wind: 5.5m/s

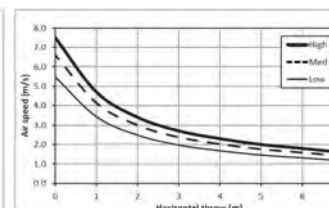

MMK-UP0361HP-E

High wind: 8.0m/s
Mid wind: 7.2m/s
Low wind: 6.5m/s

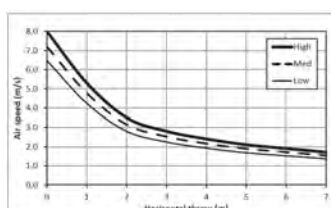

High wall connectors

• : Available

CN32	CN60	CN61	CN70	CN73	CN80
Additional ventilation control from remote control	Operation status signal output (Cooling, fan, thermo-on)	External On/Off, operation output and alarm output	Warning symbol on remote control based on signal input.	Forced IDU thermo-off based on signal input	Forced IDU thermo-off and IDU lock based on signal input
•	•	•	TCB-PCUC2E PCB needed	TCB-PCUC2E PCB needed	•



MMZ-UP0091F/MMZ-UP0091D
ZONING AIRCONDITIONING UNIT

> NEW



Zoning airconditioning unit can be operated efficiently by supplying the required amount of cold air in specific spot or zone.

CAPACITY



1 HP

SOUND PRESSURE LEVEL



47/42 dB(A)

LOCAL CONTROLS



RBC-ASCU11-E
RBC-AMTU31-E
RBC-AMSU51-EN/ES

Features

Model name		MMZ-	UP0091F Auto flap type	UP0091D Duct flange type
Capacity code		HP	1.0	1.0
Cooling capacity		kW	2.8	2.8
Electrical characteristics	Power supply	1 phase 50Hz 220-240V / 1 phase 60Hz 220V		
	Running current (50Hz/60Hz)	A	0.53/0.56	0.53/0.56
	Power consumption (50Hz/60Hz)	kW	0.061/0.061	0.061/0.061
	Starting current (50Hz/60Hz)	A	0.74/0.74	0.74/0.74
Appearance		Silky shade (Munsell: 1Y 8.5 / 0.5)		
Outer Dimensions (HxWxD)		mm	500x500x322	500x500x322
Total weight		kg	13	15
Heat exchanger		Finned tube		
Soundproof / Heat-insulating material		Acrylonitrile styrene foam		
Fan unit	Fan	Propeller fan		
	Standard air flow (H/M/L)	m ³ /h	912/726/558	
	Air flow range	m ³ /h	342-912	
	External static pressure (factory setting)	Pa	-	10
	External static pressure*	Pa	-	75
Sound pressure level (H/M/L)		dB(A)	57/52/47	52/48/42
Sound power level (H/M/L)		dB(A)	72/67/62	72/67/61
Air filter (Optional)		Standard filter		
Controller (Optional)		Wired and infrared remote controller		
Connecting pipe	Gas side	mm	9.5	
	Liquid side	mm	6.4	
	Drain port (nominal dia)	mm	25	R1

Avoid installing in the following places.

- A kitchen in restaurant or places around machines and equipment in a factory, where a lot of oils are used. (Oil adhering to the heat exchanger and the resin parts in the indoor unit may lower the unit performance, splash water drops, or produce mist and may cause the resin parts to be deformed or damaged.)
- Places where iron or other metal dust is present. If iron or other metal dust adheres to or collects on the interior of the air conditioner, it may spontaneously combust and start a fire.

Drawings

Unit : mm

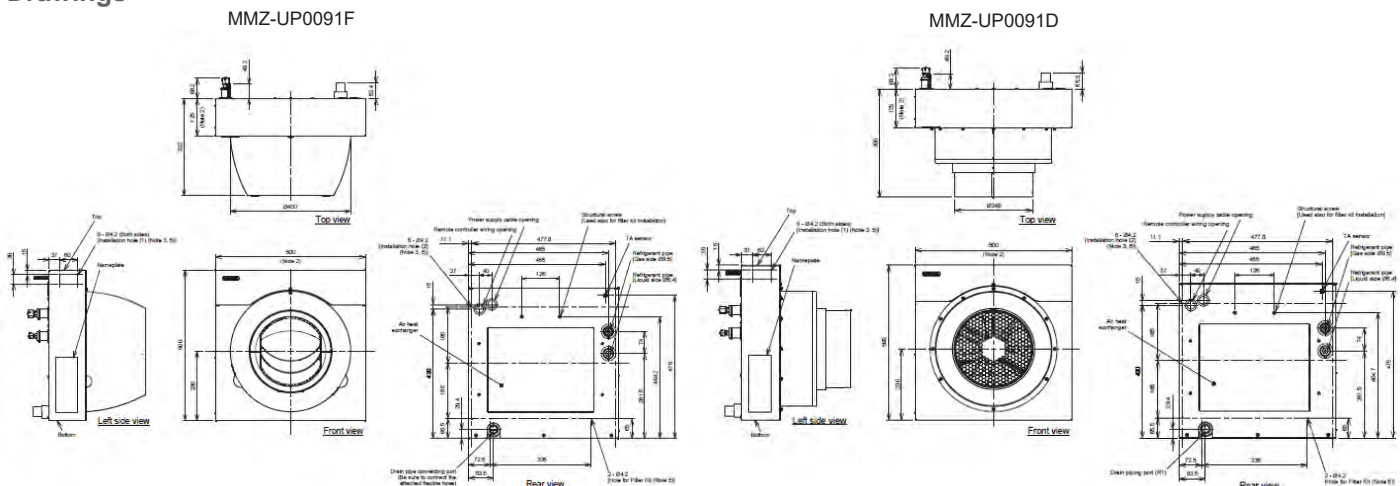

ZONING AIRCONDITIONING UNIT

Sound pressure levels

Unit : dB(A)

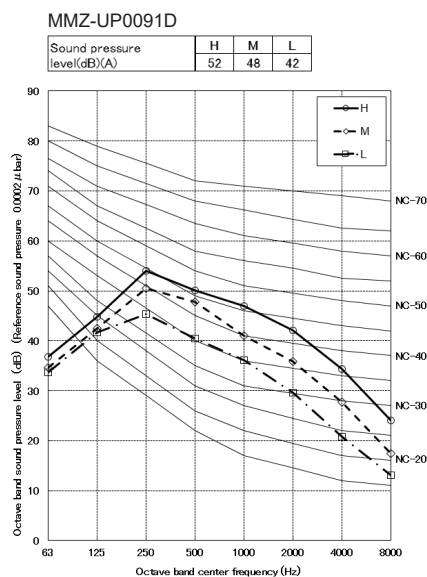
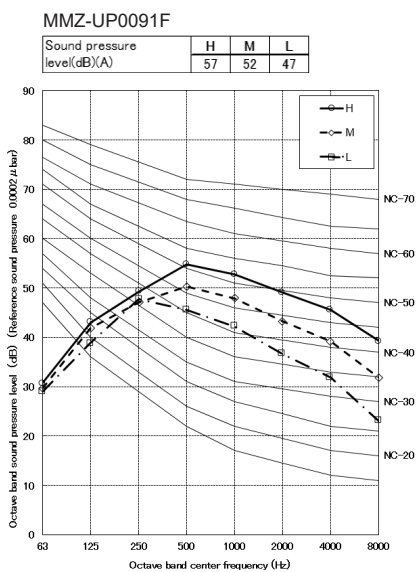

Air diffusion

Unit : m/s

MMZ-UP0091F

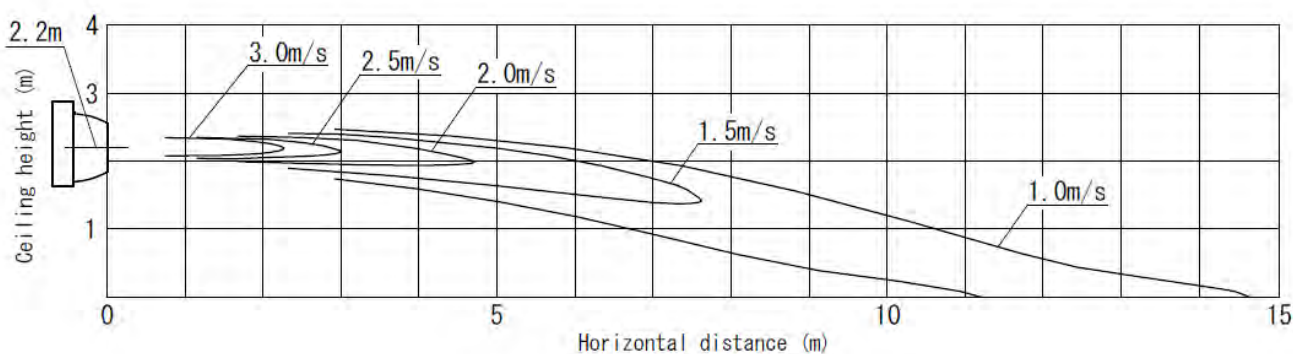

Accessories

No.	Part name	Model name	Applied model	Notes	Remarks
1	Hanging fitting	TCB-TK0091Z-E	MMZ-UP0091F & MMZ-UP0091D	For installing by hanging bolt	
2	Fixing bracket	TCB-TB0091Z-E		For installing on the pillar and wall	
3	Filter kit	TCB-LK0091Z-E			
4	Replacement filter	TCB-PF0091Z-E			
5	Extension valve kit	TCB-VA0091Z-E			

Zoning airconditioning unit connectors

• : Available

CN32	CN60	CN61	CN70	CN73	CN80
Additional ventilation control from remote control	Operation status signal output (Cooling, fan, thermo-on)	External On/Off, operation output and alarm output	Warning symbol on remote control based on signal input.	Forced IDU thermo-off based on signal input	Forced IDU thermo-off and IDU lock based on signal input
•	TCB-PCUC2E PCB needed	•	TCB-PCUC2E PCB needed	TCB-PCUC2E PCB needed	TCB-PCUC2E PCB needed

MML-UP_1BH-E
FLOOR STANDING CONCEALED



This slim unit is designed to easily fit into a compact space and to perfectly integrate itself behind a decorative panel. This is the ideal solution that blends into any interior.

CAPACITY
↑
0.8 HP - 2.5 HP

SOUND PRESSURE LEVEL
🔊
32 dB(A)

LOCAL CONTROLS



RBC-AXU31-E



RBC-ASCU11-E
RBC-AMTU31-E
RBC-AMSU51-EN/ES

Features

Model name	MML-	UP0071BH-E	UP0091BH-E	UP0121BH-E	UP0151BH-E	UP0181BH-E	UP0241BH-E	
Capacity code	HP	0.8	1.0	1.25	1.7	2.0	2.5	
Cooling capacity	kW	2.2	2.8	3.6	4.5	5.6	7.1	
Electrical characteristics	Power supply	1 phase 50Hz 230V (220-240V) / 1 phase 60Hz 220V						
	Running current (50Hz/60Hz)	A	0.25/0.27		0.45/0.46		0.46/0.51	
	Power consumption (50Hz/60Hz)	kW	0.056/0.058		0.090/0.096		0.095/0.110	
	Starting current (50Hz/60Hz)	A	0.60/0.60		0.80/0.80		1.00/1.00	
Appearance		Zinc hot dipping steel plate						
Dimensions (HxWxD)	mm	600x745x220			600x1045x220			
Total weight	kg	21			28			
Heat exchanger		Finned tube						
Soundproof / Heat-insulating material		Non-flammable insulation						
Fan unit	Fan	Centrifugal fan						
	Standard air flow (H/M/L)	m³/h	460/400/300		740/600/490		950/790/640	
	Motor output	W	19		70			
Sound pressure level (H/M/L)	dB(A)	36/34/32					42/37/33	
Sound power level	dB(A)	54					60	
Air filter		Standard filter supplied (Simple filter)						
Controller (Optional)		Wired or infrared remote controller						
Connecting pipe	Gas side	mm	9.5	9.5	9.5	12.7	12.7	15.9
	Liquid side	mm	6.4	6.4	6.4	6.4	6.4	9.5
	Drain port (nominal dia)	mm	20 (Polyvinyl chloride tube)					

Drawings

Unit : mm

All model

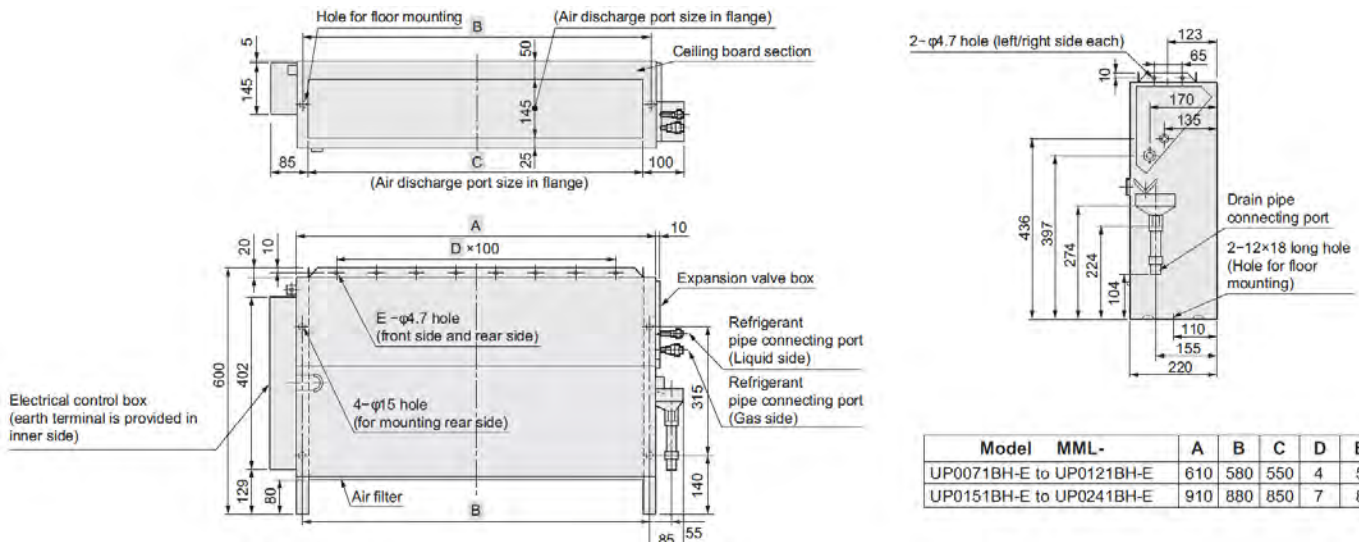

Model	MML-	A	B	C	D	E
UP0071BH-E to UP0121BH-E		610	580	550	4	5
UP0151BH-E to UP0241BH-E		910	880	850	7	8

FLOOR STANDING CONCEALED

Sound pressure levels

Unit : dB(A)

MML-UP0071, 0091, 0121BH-E

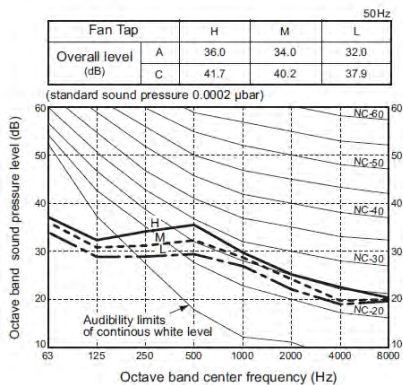

MML-UP0151, 0181BH-E

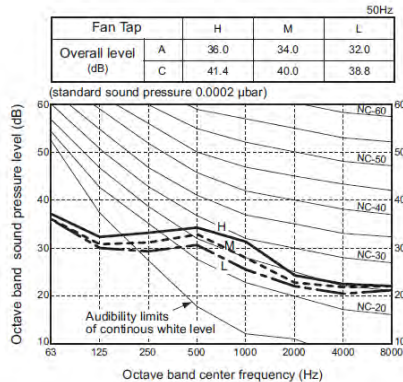

MML-UP0241BH-E

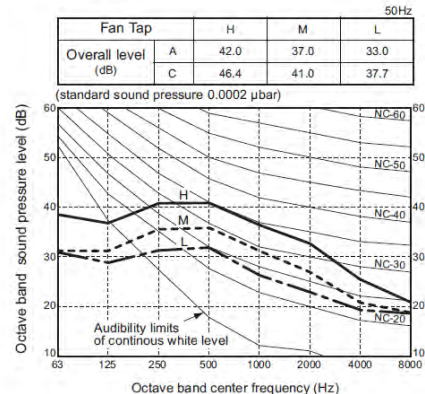

Floor standing concealed connectors

• : Available

CN32	CN60	CN61	CN70	CN73	CN80
Additional ventilation control from remote control	Operation status signal output (Cooling, fan, thermo-on)	External On/Off, operation output and alarm output	Warning symbol on remote control based on signal input.	Forced IDU thermo-off based on signal input	Forced IDU thermo-off and IDU lock based on signal input
•	•	•	•	•	•

↑ IDU

MML-UP_1H-E
FLOOR STANDING CABINET



The simple design of this unit represents the perfect choice for refurbishment projects, where the available space is limited, or where neither the walls nor ceiling is able to house the unit.

CAPACITY
↑↑
0.8 HP - 2.5 HP

SOUND PRESSURE LEVEL
🔊
35 dB(A)

LOCAL CONTROLS



RBC-AXU31-E



RBC-ASCU11-E
RBC-AMTU31-E
RBC-AMSU51-EN/ES

Features

Model name	MML-	UP0071H-E	UP0091H-E	UP0121H-E	UP0151H-E	UP0181H-E	UP0241H-E	
Capacity code	HP	0.8	1.0	1.25	1.7	2.0	2.5	
Cooling capacity	kW	2.2	2.8	3.6	4.5	5.6	7.1	
Electrical characteristics	Power supply	1 phase 50Hz 230V (220-240V) / 1 phase 60Hz 220V						
	Running current (50Hz/60Hz)	A	0.26/0.25		0.43/0.44		0.47/0.53	
	Power consumption (50Hz/60Hz)	kW	0.056/0.044		0.092/0.069		0.102/0.076	
	Starting current (50Hz/60Hz)	A	0.60/0.60		0.80/0.80		1.10/1.10	
Appearance		Silky shade (1Y8.5/0.5)						
Dimensions (HxWxD)	mm	630x950x230						
Total weight	kg	35				38		
Heat exchanger		Finned tube						
Soundproof / Heat-insulating material		Non-flammable insulation						
Fan unit	Fan	Centrifugal fan						
	Standard air flow (H/M/L)	m³/h	480/420/360		900/780/650		1080/930/780	
	Motor output	W	45			70		
Sound pressure level (H/M/L)	dB(A)	39/37/35		45/41/38		49/44/39		
Sound power level	dB(A)	54		60		64		
Air filter		Standard filter supplied (Simple filter)						
Controller (Optional)		Wired or infrared remote controller						
Connecting pipe	Gas side	mm	9.5	9.5	9.5	12.7	12.7	15.9
	Liquid side	mm	6.4	6.4	6.4	6.4	6.4	9.5
	Drain port (nominal dia)	mm	20 (Polyvinyl chloride tube)					

Drawings

Unit : mm

All model

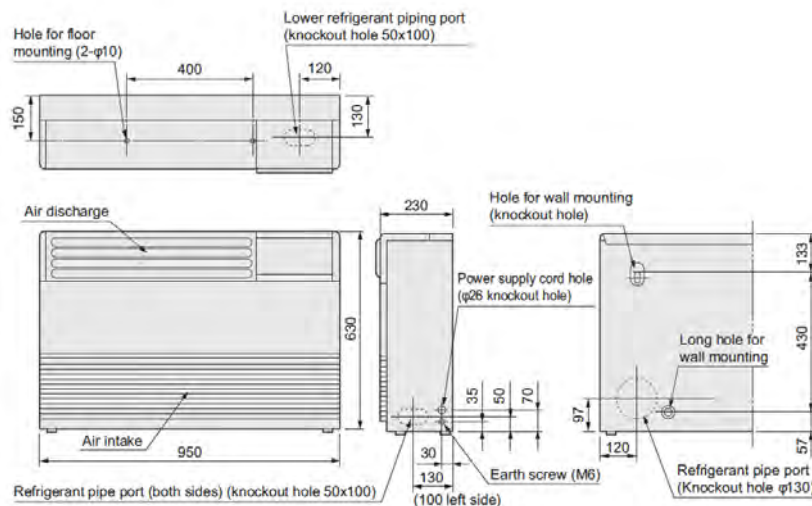

FLOOR STANDING CABINET

Sound pressure levels

Unit : dB(A)

MML-UP0071, 0091H-E

Fan tap	H	M	L
Sound pressure level (dB(A))	39	37	35

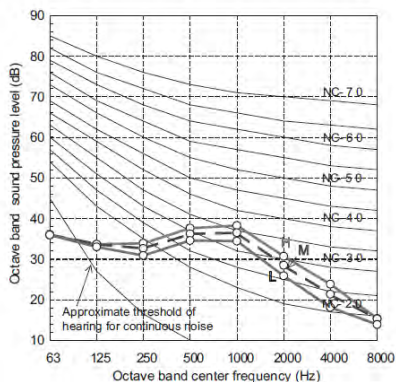

MML-UP0121, 0151H-E

Fan tap	H	M	L
Sound pressure level (dB(A))	45	41	38

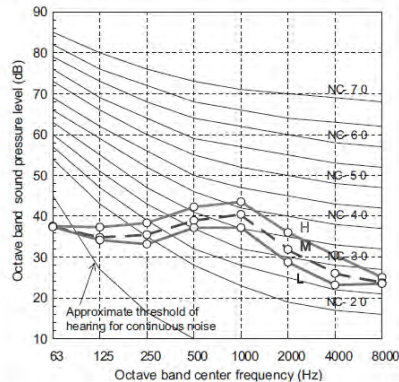

MML-UP0181, 0241H-E

Fan tap	H	M	L
Sound pressure level (dB(A))	49	44	39

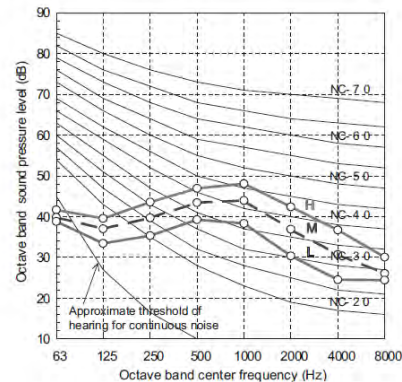

Air diffusion

Unit : m/s

MML-UP0071, 0091H-E

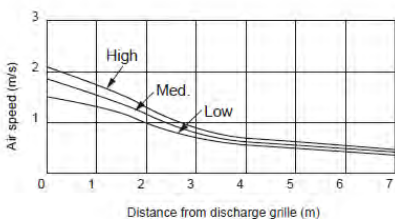

MML-UP0121, 0151H-E

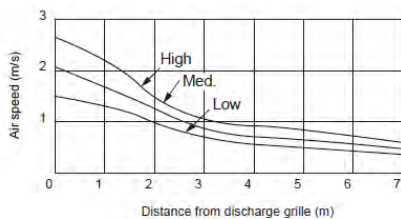

MML-UP0181, 0241H-E

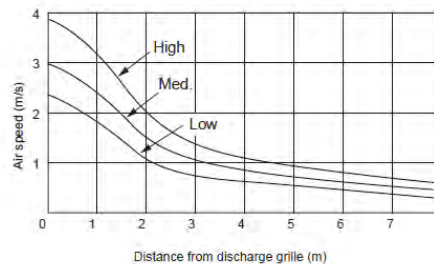

Floor standing cabinet connectors

• : Available

CN32	CN60	CN61	CN70	CN73	CN80
Additional ventilation control from remote control	Operation status signal output (Cooling, fan, thermo-on)	External On/Off, operation output and alarm output	Warning symbol on remote control based on signal input.	Forced IDU thermo-off based on signal input	Forced IDU thermo-off and IDU lock based on signal input
•	•	•	•	•	•



Innovative and compact unit to be installed on the floor and in low wall applications, fits perfectly under the window sills or in a low ceiling attic.

CAPACITY



0.8 HP - 2 HP

SOUND PRESSURE LEVEL



26 dB(A)

LOCAL CONTROLS



Included



RBC-ASCU11-E
RBC-AMTU31-E
RBC-AMSU51-EN/ES

Features

Model name	MML-	UP0071NHP-E	UP0091NHP-E	UP0121NHP-E	UP0151NHP-E	UP0181NHP-E	
Capacity code	HP	0.8	1.0	1.25	1.7	2.0	
Cooling capacity	kW	2.2	2.8	3.6	4.5	5.6	
Electrical characteristics	Power supply	1 phase 50Hz 230V (220-240V) / 1 phase 60Hz 220V					
	Running current (50Hz/60Hz)	A	0.20/0.17	0.20/0.17	0.23/0.19	0.29/0.25	0.42/0.36
	Power consumption (50Hz/60Hz)	kW	0.021/0.021	0.021/0.021	0.025/0.025	0.034/0.034	0.052/0.052
	Starting current (50Hz/60Hz)	A	0.26/0.22	0.26/0.22	0.30/0.30	0.33/0.38	0.55/0.55
Appearance	Air intake grille and side panel	Moon white (Munsell : 2.5GY 9.0/0.5)					
	Discharge-grille	Moon white (Munsell : 2.5GY 9.0/0.5)					
	Bottom surface	Moon white (Munsell : 2.5GY 9.0/0.5)					
Dimensions (HxWxD)	mm	600x700x220					
Total weight	kg	17					
Heat exchanger		Finned tube					
Soundproof / Heat-insulating material		Foamed polystyrene / Polyethylene					
Fan unit	Fan	Turbo fan					
	Standard air flow (H/M/L)	m ³ /h	510/366/282	510/366/282	552/408/324	624/468/384	726/528/426
	Motor output	W	41				
Sound pressure level (H/M/L)	dB(A)	38/32/26	38/32/26	40/34/29	43/37/31	47/40/34	
Sound power level	dB(A)	53	53	55	58	62	
Air filter		Standard filter supplied (Long life filter)					
Controller (Packed with indoor unit)		Wireless remote controller					
Connecting pipe	Gas side	mm	9.5	9.5	9.5	12.7	12.7
	Liquid side	mm	6.4	6.4	6.4	6.4	6.4
	Drain port (nominal dia)	mm	16 (Polypropylene tube)				

Drawings

Unit : mm

All model

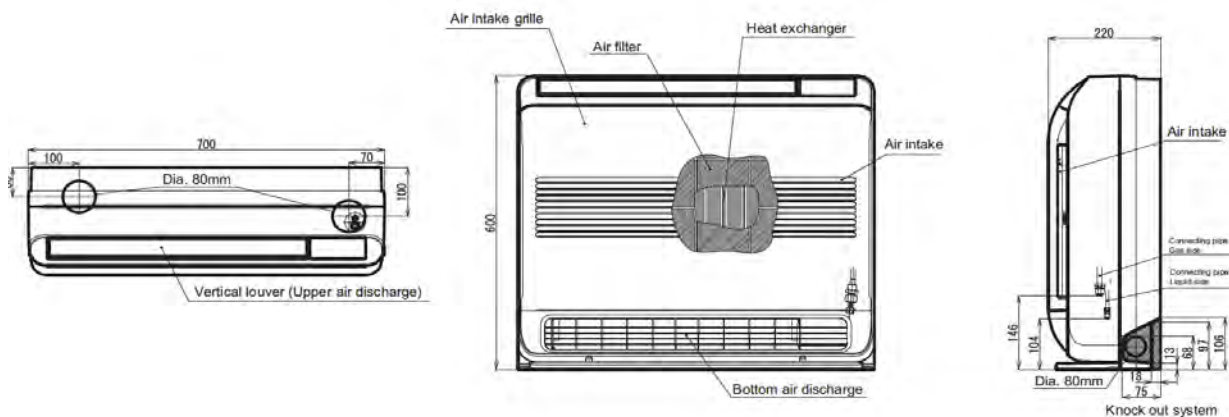

CONSOLE

Sound pressure levels

Unit : dB(A)

MML-UP0071, 0091NHP-E

Fan tap	H	M	L
Sound pressure level (dB(A))	38	32	26

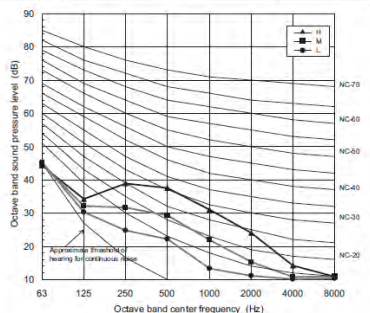

MML-UP0121NHP-E

Fan tap	H	M	L
Sound pressure level (dB(A))	40	34	29

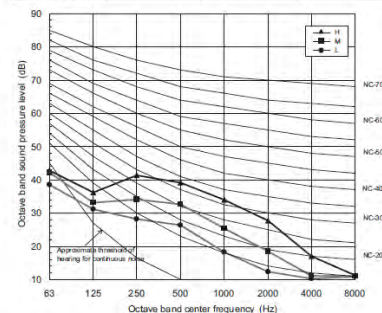

MML-UP0151NHP-E

Fan tap	H	M	L
Sound pressure level (dB(A))	43	37	31

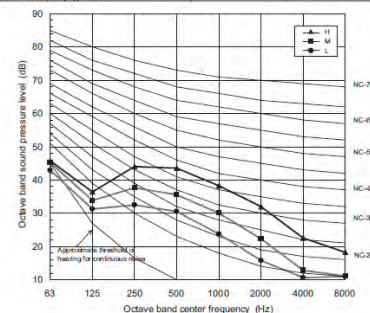

MML-UP0181NHP-E

Fan tap	H	M	L
Sound pressure level (dB(A))	47	40	34

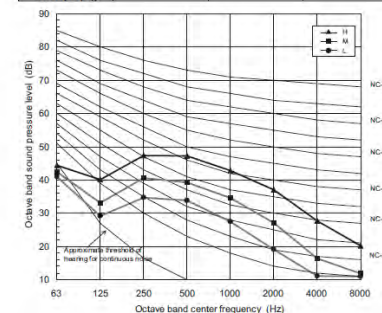

Air diffusion

Unit : m/s

MML-UP0071, 0091NHP-E

Cooling - Upper & Lower

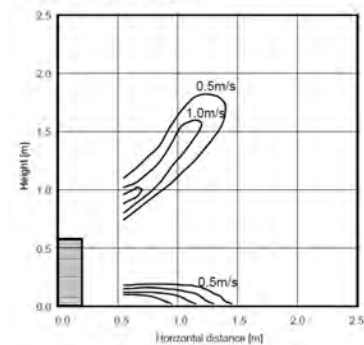

MML-UP0121NHP-E

Cooling - Upper & Lower

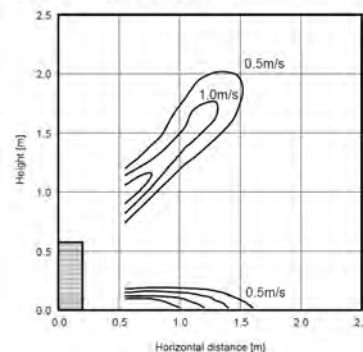

MML-UP0151NHP-E

Cooling - Upper & Lower

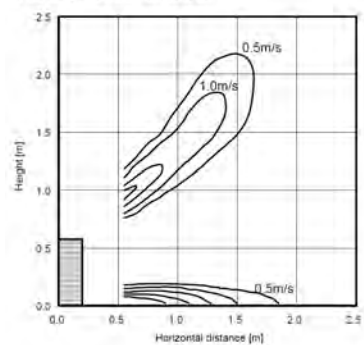

MML-UP0181NHP-E

Cooling - Upper & Lower

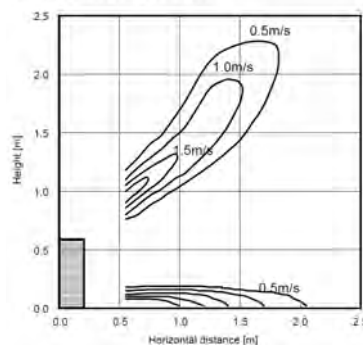

Console connectors

• : Available

CN32	CN60	CN61	CN70	CN73	CN80
Additional ventilation control from remote control	Operation status signal output (Cooling, fan, thermo-on)	External On/Off, operation output and alarm output	Warning symbol on remote control based on signal input.	Forced IDU thermo-off based on signal input	Forced IDU thermo-off and IDU lock based on signal input
•	•	•	TCB-PCUC2E PCB needed	TCB-PCUC2E PCB needed	•

MMF-UP_1H-E
FLOOR STANDING



This system is particularly suitable for large rooms air condition like shops, showrooms and with low ceilings like restaurants.

LOCAL CONTROLS



CAPACITY



1.7 HP - 6 HP

SOUND PRESSURE LEVEL



38 dB(A)

Features

Model name	MMF-	UP0151H-E	UP0181H-E	UP0241H-E	UP0271H-E	UP0361H-E	UP0481H-E	UP0561H-E
Capacity code	HP	1.7	2.0	2.5	3.0	4.0	5.0	6.0
Cooling capacity	kW	4.5	5.6	7.1	8.0	11.2	14.0	16.0
Electrical characteristics	Power supply	1 phase 50Hz 230V (220-240V) / 1 phase 60Hz 220V						
	Running current (50Hz/60Hz)	A	0.37/0.38		0.55/0.58		0.82/0.86	0.97/1.02
	Power consumption (50Hz/60Hz)	kW	0.053/0.053		0.087/0.087		0.133/0.133	0.158/0.158
	Starting current (50Hz/60Hz)	A	0.48/0.50		0.71/0.75		1.06/1.11	1.27/1.33
Appearance		Silky shade (Munsell / 1Y 8.5 / 8.0)						
Dimensions (HxWxD)	mm	1750x600x210				1750x600x390		
Total weight	kg	46		47		61		
Heat exchanger		Finned tube						
Soundproof / Heat-insulating material		Non-flammable insulation						
Fan unit	Fan	Centrifugal fan						
	Standard air flow (H/M/L)	m³/h	820/700/600		930/770/640		1660/1420/1170	1760/1480/1350
	Motor output	W	62				109	
Sound pressure level (H/M/L)	dB(A)	46/42/38		50/45/41		51/46/41	53/48/45	
Sound power level	dB(A)	64		67		69	72	
Air filter		Standard filter supplied (Simple filter)						
Controller (Optional)		Wired or infrared remote controller						
Connecting pipe	Gas side	mm	12.7	12.7	12.7	12.7	12.7	12.7
	Liquid side	mm	6.4	6.4	6.4	9.5	9.5	9.5
	Drain port (nominal dia)	mm	20 (Polyvinyl chloride tube)					

Drawings

Unit : mm

MMF-UP0151H-E to MMF-UP0271H-E

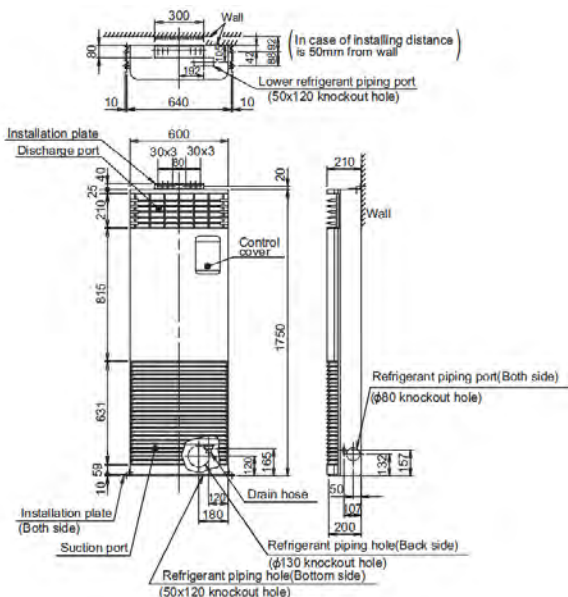

MMF-UP0361H-E to MMF-UP0561H-E

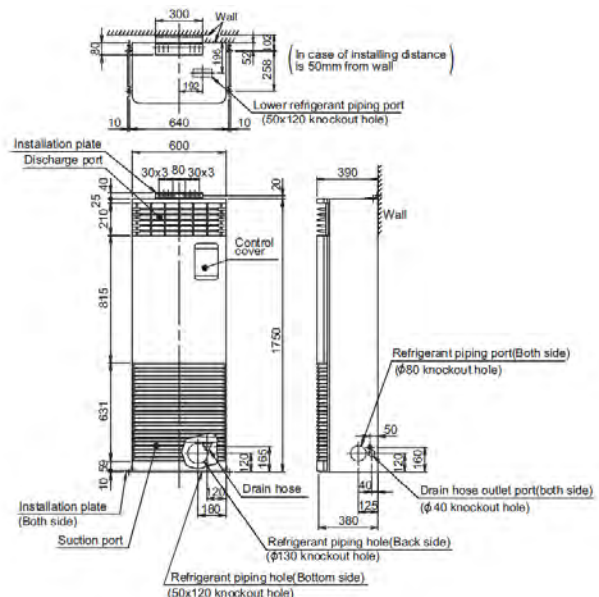

FLOOR STANDING

Sound pressure levels

Unit : dB(A)

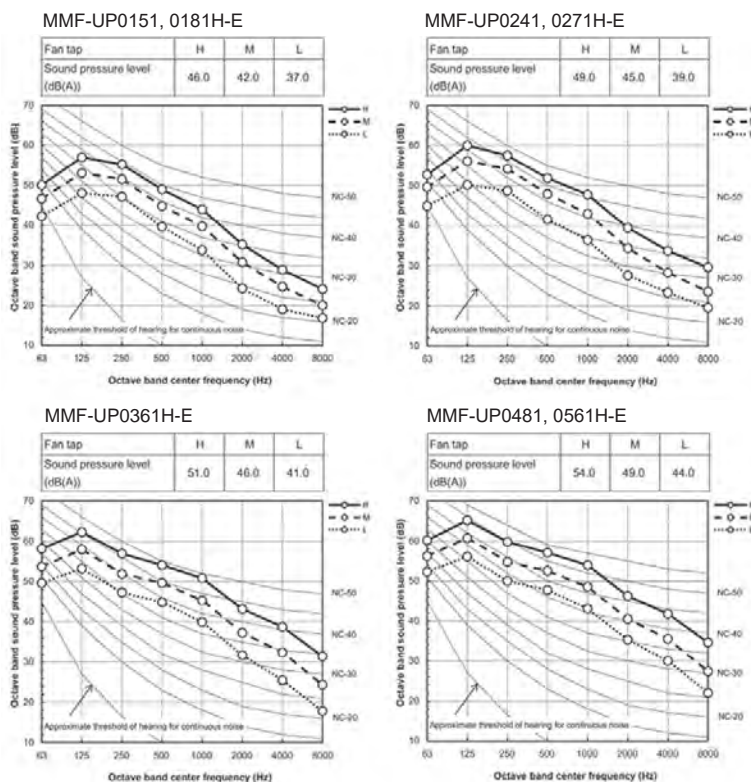

Air diffusion

Unit : m/s

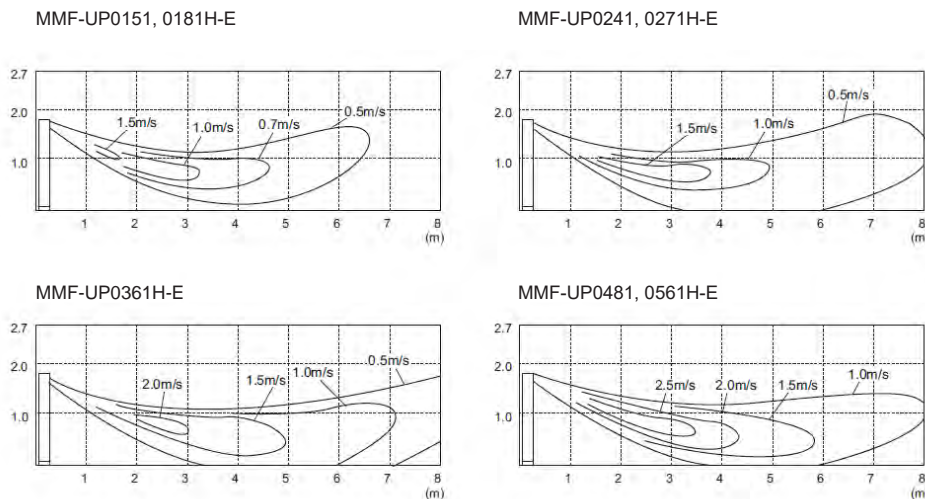

Floor standing connectors

• : Available

CN32	CN60	CN61	CN70	CN73	CN80
Additional ventilation control from remote control	Operation status signal output (Cooling, fan, thermo-on)	External On/Off, operation output and alarm output	Warning symbol on remote control based on signal input.	Forced IDU thermo-off based on signal input	Forced IDU thermo-off and IDU lock based on signal input
•	TCB-PCUC2E PCB needed	•	TCB-PCUC2E PCB needed	TCB-PCUC2E PCB needed	TCB-PCUC2E PCB needed

MMF-AP_5(D)HP-VA/VB
LARGE CAPACITY FLOOR STANDING



This system is particularly suitable for large rooms air conditioning like warehouse, factory and shopping mall.

CAPACITY



8 HP - 20 HP

AIR FLOW



Up to 3,600m³/h - 8,400m³/h

SOUND PRESSURE LEVEL



59 dB(A)

LOCAL CONTROLS



RBC-AXU31-E



RBC-AMTU31-E
RBC-AMSU51-EN/ES

Features

Model name	MMF-	Ducted Type				Direct Blow Type				
		AP0725DHP-VA	AP0965DHP-VA	AP1445DHP-VA	AP1925DHP-VA	AP0725HP-VA	AP0965HP-VA	AP1445HP-VA	AP1925HP-VA	
Capacity code	HP	8	10	16	20	8	10	16	20	
Cooling capacity	kW	22.4	28.0	45.0	56.0	22.4	28.0	45.0	56.0	
Electrical characteristics	Power supply	VA: 3 phase 50Hz 380-415V / VB: 3 phase 60Hz 380V								
	Running current (50Hz/60Hz)	A	1.68/1.69	2.85/2.74	4.26/4.16	5.67/5.18	1.42/1.29	2.27/1.94	2.91/2.54	3.77/3.49
	Power consumption (50Hz/60Hz)	kW	0.83/0.93	1.35/1.48	2.30/2.41	2.67/2.80	0.62/0.67	0.80/0.86	1.28/1.31	1.96/1.98
	Starting current (50Hz/60Hz)	A	9.4/8.2	19.6/17.7	31.5/27.0	45.6/42.0	9.4/8.2	19.6/17.7	31.5/27.0	31.5/27.0
Appearance		Cream (5Y 7/1.5)								
Dimensions (HxWxD)	mm	1820x890x540		1870x1300x760		2130x890x540		2280x1300x760		
Total weight	kg	150	155	280	290	170	175	320		
Heat exchanger		Copper tubes, Aluminum plate fins								
Soundproof / Heat-insulating material		Polyolefin form								
Fan unit	Fan	Multi blades centrifugal; Belt drive								
	Standard air flow	m ³ /h	3600	4500	7200	8400	3600	4200	7200	8400
	Air flow limit (Lower/Upper)	m ³ /h	2880/4320	3360/5040	5760/8640	6720/10080	2880/4320	3360/5040	5760/8640	6720/10080
	External static pressure	Pa	200	300	300	300	-	-	-	-
Sound pressure level	dB(A)	59	64	66	68	60	64	63	66	
Air filter		Standard filter supplied (Simple filter)								
Controller (Optional)		Remote controller								
Connecting pipe	Gas side	mm	22.2		28.6		22.2		28.6	
	Liquid side	mm	12.7		15.9		12.7		15.9	
	Drain port (nominal dia)	mm	25 (Both sides of male screw)							

*1: Because these models can support only old communication protocol, please communicate with local distributor if you want to connect these indoor units.

Drawings

Unit : mm

MMF-AP0725DHP-VA/VB,
MMF-AP0965DHP-VA/VB

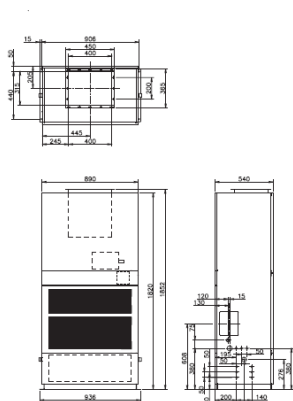

MMF-AP1445DHP-VA/VB,
MMF-AP1925DHP-VA/VB

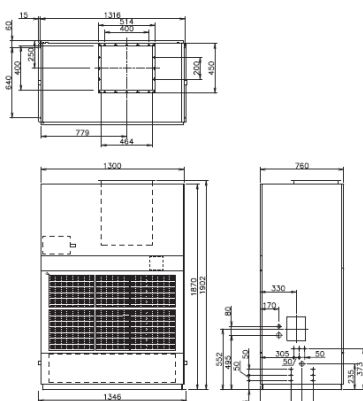

MMF-AP0725HP-VA/VB,
MMF-AP0965HP-VA/VB

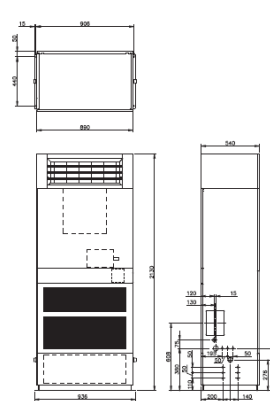

MMF-AP1445HP-VA/VB,
MMF-AP1925HP-VA/VB

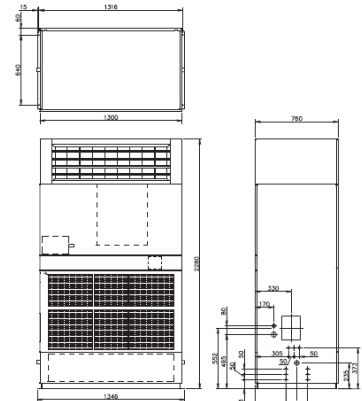

LARGE CAPACITY FLOOR STANDING

Sound pressure levels

Unit : dB(A)

MMF-AP0725DHP-VA/VB

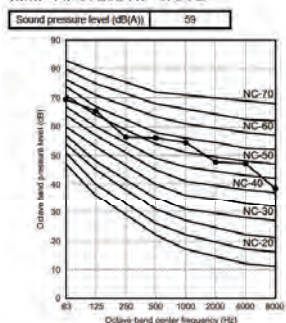

MMF-AP0965DHP-VA/VB

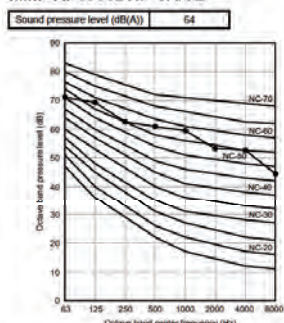

MMF-AP1445DHP-VA/VB

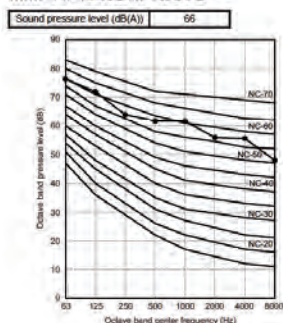

MMF-AP1925DHP-VA/VB

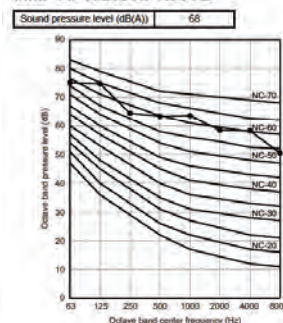

MMF-AP0725HP-VA/VB

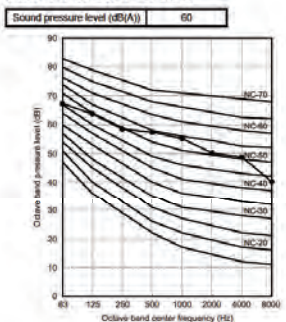

MMF-AP0965HP-VA/VB

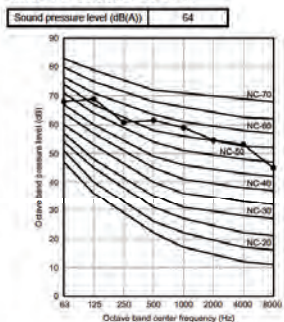

MMF-AP1445HP-VA/VB

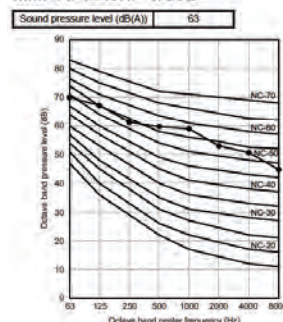

MMF-AP1925HP-VA/VB

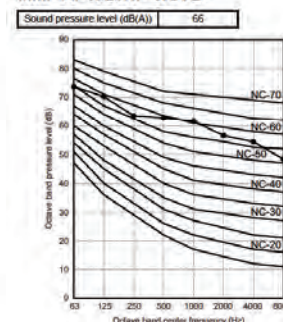

Air diffusion

Unit : m/s

MMF-AP0725HP-VA(VB)

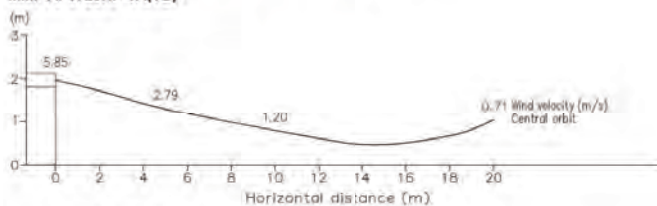

MMF-AP0965HP-VA(VB)

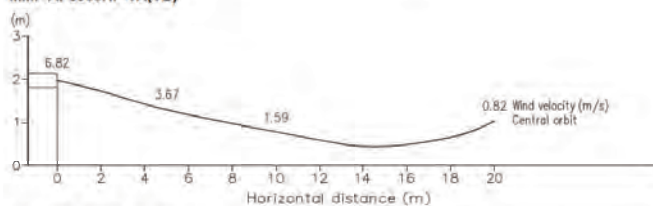

MMF-AP1445HP-VA(VB)

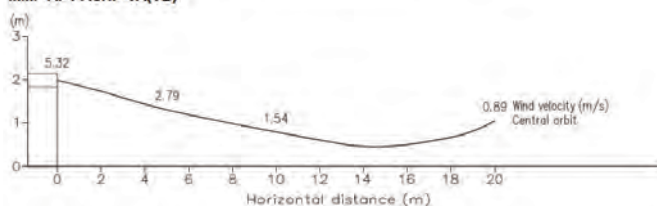

MMF-AP1925HP-VA(VB)

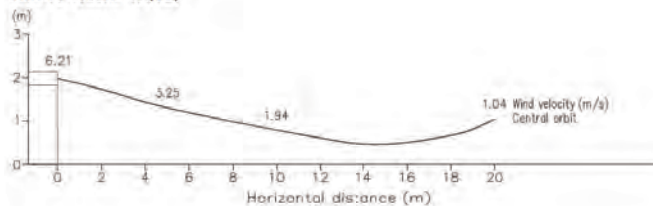

Large capacity floor standing connectors

• : Available

CN32	CN60	CN61	CN70	CN73	CN80
Additional ventilation control from remote control	Operation status signal output (Cooling, fan, thermo-on)	External On/Off, operation output and alarm output	Warning symbol on remote control based on signal input.	Forced IDU thermo-off based on signal input	Forced IDU thermo-off and IDU lock based on signal input
•	TCB-PCUC2E PCB needed	•	TCB-PCUC2E PCB needed	TCB-PCUC2E PCB needed	TCB-PCUC2E PCB needed



MMD-VN
AIR-TO-AIR HEAT EXCHANGER WITH DX-COIL



MMD-VN ventilation products are using exhaust air + DX-coil to pre-condition the incoming air, thus reducing the cooling load and the overall size of the required air conditioning system.

CAPACITY



4.1 kW ~ 8.25 kW

AIR FLOW



Up to 500m³/h ~ 950m³/h

SOUND PRESSURE LEVEL



34.5 dB(A)

LOCAL CONTROLS



NRC-01HE
RBC-AMTU31E

Features

Model name		MMD-	Without humidifier				
			VN502HEX1E	VN802HEX1E	VN1002HEX1E	VN1002HEX1E2	
Cooling capacity		kW	4.10(1.30)	6.56(2.06)	8.25(2.32)	8.25(2.32)	
Power supply			1 phase 50Hz 230V (220-240V) / 1 phase 60Hz 220V		1 phase 50Hz 230V(220V-240V)	1 phase 60Hz 220V	
Temperature exchange efficiency	Extra high/High/Low	%	70.5/71.5/72.0	70.5/72.5/73.0	65.5/67.5/68.0	65.5/67.5/68.0	
Enthalpy exchange efficiency (%)	Cooling (Extra high/High/Low)	%	56.5/57.5/58.0	56.0/59.0/59.5	52.0/54.0/55.0	52.0/54.0/55.0	
Power input (Heat exchange mode)	Extra high	kw	0.300/0.365	0.505/0.595	0.550	0.720	
	High	kw	0.280/0.350	0.465/0.555	0.545	0.665	
	Low	kw	0.235/0.250	0.335/0.390	0.485	0.530	
Running current	Extra high	A	1.30/1.65	2.25/2.77	2.46	3.38	
	High	A	1.21/1.62	2.07/2.59	2.43	3.11	
	Low	A	1.01/1.14	1.46/1.79	2.16	2.45	
Fan unit	Standard air flow	Extra high	m ³ /h	500/-	800/-	950	950
		High	m ³ /h	500/-	800/-	950	950
		Low	m ³ /h	440/410	640/600	820	800
	External static pressure	Extra high	Pa	120/200	120/190	135	195
		High	Pa	105/170	100/155	120	160
		Low	Pa	115/150	100/130	105	130
	Air flow limit	Lower limit	m ³ /h	330	480	640	640
Upper limit		m ³ /h	600	960	1140	1140	
Sound pressure level	Extra high	dB(A)	37.5/40	41/43	43	43.5	
	High	dB(A)	36.5/38	40/42	42	42	
	Low	dB(A)	34.5/36.5	38/37	40	40	
Sound power level		dB(A)	55	58	59	59	
Appearance			Zinc hot dipping steel plate				
Dimensions (HxWxD)		mm	430x1140x1690	430x1189x1739	430x1189x1789	430x1189x1789	
Weight		kg	84	100	101	101	
Heat exchanger / Heat-insulating material			Finned tube / Flexible urethane foam				
Air filter			Standard filter & High efficiency filter				
Controller			Remote controller (Separately sold parts)				
Connecting pipe	Gas side / Liquid side	mm	9.5 / 6.4	12.7 / 6.4	12.7 / 6.4	12.7 / 6.4	
	Drain port (nominal dia)	mm	25 (Polyvinyl chloride tube)				
Water supply connection (Port size)			-	-	-	-	
Operating range	Around unit		-10 - 40°C . RH ≤80%				
	Outdoor Air (OA)		-15 - 43°C . RH ≤80%				
	Return Air (RA)		5 - 40°C . RH ≤80%				

*1: Because these models can support only old communication protocol, please communicate with local distributor if you want to connect these indoor units.

Cooling capacities are based on the following conditions:
Cooling capacities are based on: indoor temperature: 27°CDB/19°C WB, Outdoor temperature: 35°C DB
The figures in () indicate the heat reclaimed from the heat recovery ventilator.

AIR-TO-AIR HEAT EXCHANGER WITH DX-COIL

Drawings

Unit : mm

MMD-VN502HEX1E

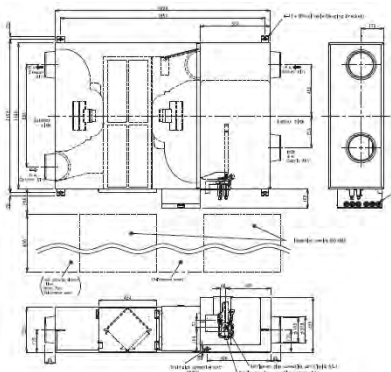

MMD-VN802HEX1E

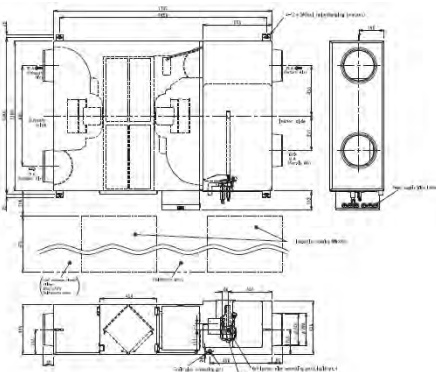

MMD-VN1002HEX1E, MMD-VN1002HEX1E2

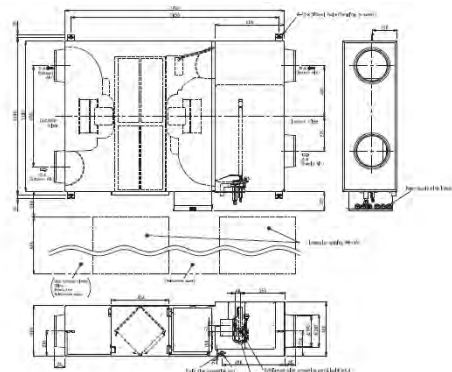

Sound pressure levels

Unit : dB(A)

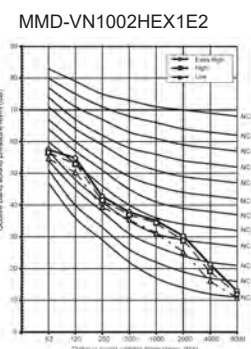
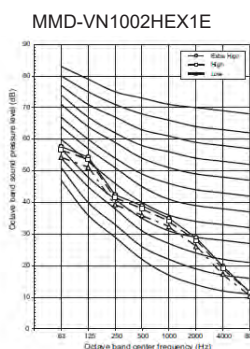
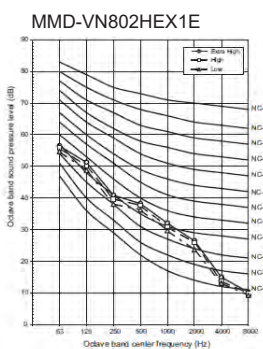
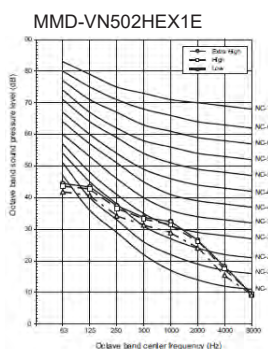

Accessories

Part name	Model name	Description	Appearance	Remarks
Control	NRC-01HE	Dedicated remote controller for air-to-air heat exchanger		Integrated functions : fan speed, freecooling, air balance volume rate, temperature management and timer.
	NRB-1HE	On/off optional PCB for air-to-air heat exchanger		
Condensates	TCB-DP31HEXE	Drain pump kit		

Air-to-air heat exchanger (with DX-coil) connectors

• : Available

CN32	CN60	CN61	CN70	CN73	CN80
Additional ventilation control from remote control	Operation status signal output (Cooling, fan, thermo-on)	External On/Off, operation output and alarm output	Warning symbol on remote control based on signal input.	Forced IDU thermo-off based on signal input	Forced IDU thermo-off and IDU lock based on signal input
-	-	•	•	•	•

Other information

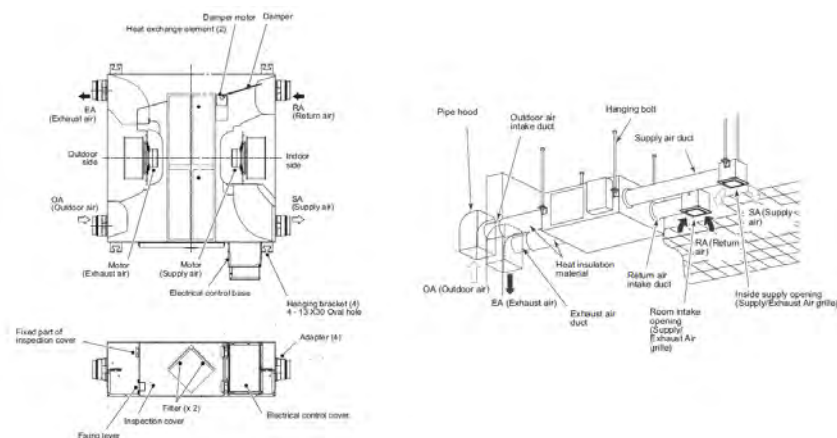

TCB-IFDMX(R)01UP-E/RBM-A_1UPVA-E
DX-COIL INTERFACE ADVANCE

NEW



Dx-coil interface advance enables to connect SMMS[∞] and third party AHU by TA, DDC or TF control condition.

CAPACITY



8 HP - 20HP

LOCAL CONTROLS



RBC-ASCU11-E
RBC-AMTU31-E
RBC-AMSU51-EN/ES

DX coil controller

Model name	TCB-	IFDMX01UP-E (Terminal block without relay)	IFDMR01UP-E (Terminal block with relay)
Power supply		1 phase 50Hz 220-240V / 1 phase 60Hz 208-230V	
Appearance		Zinc hot dipping steel plate	
Dimensions (HxWxD)	mm	420x330x122	
Total weight	kg	4.0	4.1
Controllable operation type		TA, DDC, TF	
Operable ambient condition	° C/RH	5-52 / 10-80	

DX valve kit

Model name	RBM-	A101UPVA-E				A201UPVA-E			
Capacity code	HP	8	10	12	14	16	18	20	
Dimensions (HxWxD)	mm	360x209x80							
Total weight	kg	2.3				2.4			

Single combination

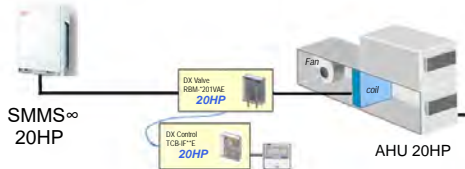

Twin combination

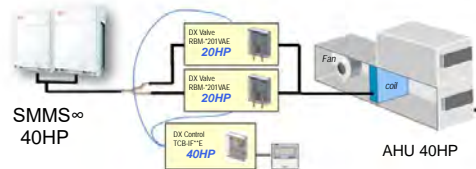

Multi combination

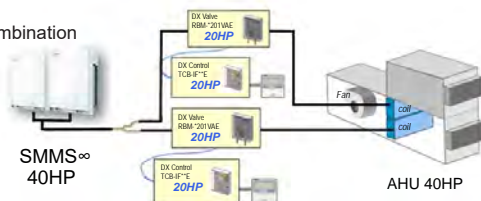

Drawings

TCB-IFDMX01UP-E
TCB-IFDMR01UP-E

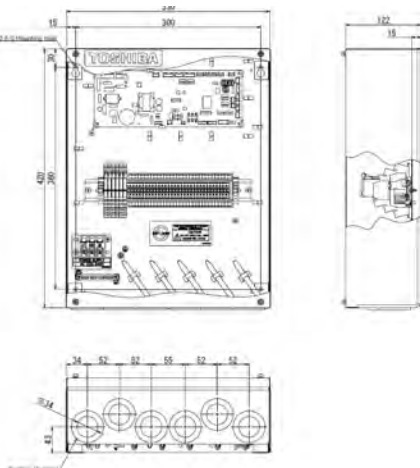

RBM-A101UPVA-E
RBM-A201UPVA-E

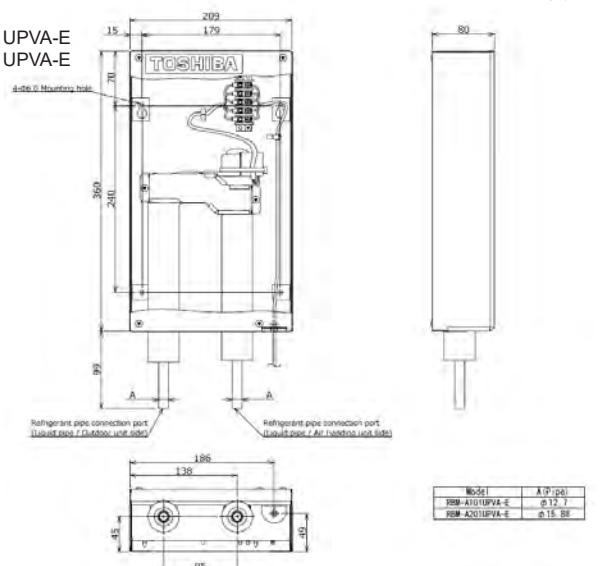

DX-COIL INTERFACE ADVANCE

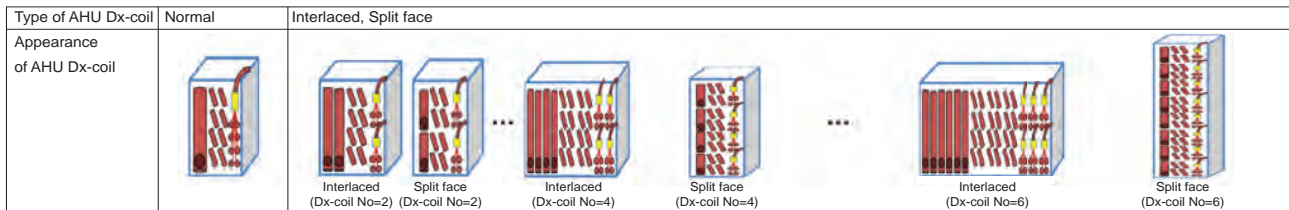

Dx-coil number	1	1	2	3	4	5	6	2	3
Dx's combination	Single	Twin	Single multi (2)	Single multi (3)	Single multi (4)	Single multi (5)	Single multi (6)	Double Twin	Triple Twin
Dx-controller No.	1	1	2	3	4	5	6	2	3
Dx-valve kit No.	1	2	2	3	4	5	6	4	6
8	8								
10	10								
12	12								
14	14								
16	16	8+8	8+8						
18	18		10+8						
20	20	10+10	10+10						
22			12+10						
24		12+12	12+12	8+8+8					
26				10+8+8					
28		14+14	14+14	10+10+8					
30			16+14	10+10+10					
32		16+16	16+16	12+10+10	8+8+8+8			(8+8)+(8+8)	
34			18+16	12+12+10	10+8+8+8				
36		18+18	18+18	12+12+12	10+10+8+8				
38			20+18		10+10+10+8				
40		20+20	20+20		10+10+10+10	8+8+8+8+8		(10+10)+(10+10)	
42				14+14+14	12+10+10+10	10+8+8+8+8			
44				16+14+14	12+12+10+10	10+10+8+8+8			
46				16+16+14	12+12+12+10	10+10+10+8+8			
48				16+16+16	12+12+12+12	10+10+10+10+8	8+8+8+8+8+8	(12+12)+(12+12)	(8+8)+(8+8)+(8+8)
50				18+16+16		10+10+10+10+10	10+8+8+8+8+8		
52				18+18+16		12+10+10+10+10	10+10+8+8+8+8		
54				18+18+18		12+12+10+10+10	10+10+10+8+8+8		
56				20+18+18	14+14+14+14	12+12+12+10+10	10+10+10+10+8+8	(14+14)+(14+14)	
58				20+20+18	16+14+14+14	12+12+12+12+10	10+10+10+10+10+8		
60				20+20+20	16+16+14+14	12+12+12+12+12	10+10+10+10+10+10		(10+10)+(10+10)+(10+10)
62					16+16+16+14		12+10+10+10+10+10		
64					16+16+16+16		12+12+10+10+10+10	(16+16)+(16+16)	
66					18+16+16+16		12+12+12+10+10+10		
68					18+18+16+16		12+12+12+12+10+10		
70					18+18+18+16	14+14+14+14+14	12+12+12+12+12+10		
72					18+18+18+18	16+14+14+14+14	12+12+12+12+12+12	(18+18)+(18+18)	(12+12)+(12+12)+(12+12)
74					20+18+18+18	16+16+14+14+14			
76					20+20+18+18	16+16+16+14+14			
78					20+20+20+18	16+16+16+16+14			
80					20+20+20+20	16+16+16+16+16		(20+20)+(20+20)	
82						18+16+16+16+16			
84						18+18+16+16+16	14+14+14+14+14+14		(14+14)+(14+14)+(14+14)
86						18+18+18+16+16	16+14+14+14+14+14		
88						18+18+18+18+16	16+16+14+14+14+14		
90						18+18+18+18+18	16+16+16+14+14+14		
92						20+18+18+18+18	16+16+16+16+14+14		
94						20+20+18+18+18	16+16+16+16+16+14		
96						20+20+20+18+18	16+16+16+16+16+16		(16+16)+(16+16)+(16+16)
98						20+20+20+20+18	18+16+16+16+16+16		
100						20+20+20+20+20	18+18+16+16+16+16		
102							18+18+18+16+16+16		
104							18+18+18+18+16+16		
106							18+18+18+18+18+16		
108							18+18+18+18+18+18	(18+18)+(18+18)+(18+18)	
110							20+18+18+18+18+18		
112							20+20+18+18+18+18		
114							20+20+20+18+18+18		
116							20+20+20+20+18+18		
118							20+20+20+20+20+18		
120							20+20+20+20+20+20		(20+20)+(20+20)+(20+20)

* Please refer to the guideline of Dx-coil interface advance for other combination of DX coil controller and DX valve kit.

VN-M_HE AIR-TO-AIR HEAT EXCHANGER



Toshiba's VN model uses exhaust air to pre-condition the incoming air, thus reducing the cooling load on the system. This allows the overall capacity size of the system to be reduced.

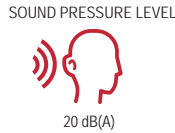

Features

Model name		VN-M150HE	VN-M250HE	VN-M350HE	VN-M500HE	VN-M650HE	VN-M800HE	VN-M1000HE	VN-M1500HE	VN-M2000HE	
Air volume (Extra high/High/Low)	m ³ /h	150/150/110	250/250/155	350/350/210	500/500/390	650/650/520	800/800/700	1000/1000/755	1500/1500/1200	2000/2000/1400	
Power consumption	Extra high	W	68-78	123-138	165-182	214-238	262-290	360-383	532-569	751-786	1084-1154
	High	W	59-67	99-111	135-145	176-192	240-258	339-353	494-538	708-784	1032-1080
	Low	W	42-47	52-69	82-88	128-142	178-191	286-300	353-370	570-607	702-742
External static pressure	Extra high	Pa	82-102	80-98	114-125	134-150	91-107	142-158	130-150	135-156	124-143
	High	Pa	52-78	34-65	56-83	69-99	58-82	102-132	97-122	103-129	92-116
	Low	Pa	47-64	28-40	65-94	62-92	61-96	76-112	84-127	112-142	110-143
Sound pressure level	Extra high	dB(A)	26-28	29.5-30	34-35	32.5-34	34-36	37-38.5	39.5-40.5	38-39	41-42.5
	High	dB(A)	24-25.5	25-27	30-32	29.5-31	33-34	35.5-37	38.5-40	36.5-37.5	39.5-41
	Low	dB(A)	20-22	21-22	27-29	26-29	31-32.5	33.5-35	34-35.5	36-37.5	37-38
Temperature exchange efficiency (%)	Extra high		81.5	78	74.5	76.5	75	76.5	73.5	76.5	73.5
	High		81.5	78	74.5	76.5	75	76.5	73.5	76.5	73.5
	Low		83	81.5	79.5	78	76.5	77.5	77	79	77.5
Enthalpy exchange efficiency (%)	Extra high	Heating	74.5	70	65	72	69.5	71	68.5	71	68.5
	High	Heating	74.5	70	65	72	69.5	71	68.5	71	68.5
	Low	Heating	76	74	71.5	73.5	71.5	71.5	71.5	73.5	72
	Extra high	Cooling	69.5	65	60.5	64.5	61.5	64	60.5	64	60.5
	High	Cooling	69.5	65	60.5	64.5	61.5	64	60.5	64	60.5
	Low	Cooling	71	69	67	66.5	64	65.5	64.5	67	65.5
Power supply		1 phase 50Hz 230V (220-240V) / 1 phase 60Hz 220V									
Dimensions (HxWxD)	mm	900x900x290			1140x1140x350		1189x1189x400		1189x1189x810		
Weight	kg	36	36	38	53	53	70	70	143	143	
Duct diameter	mm	100	150		200		250		Inside: 250 / Outside: 283x730		
Filtration efficiency grade (%)		82									
Operating range	Around unit	-10°C-40°C 80%RH or less									
	Outdoor Air (OA)	-15°C(*1)-43°C 80%RH or less									
	Return Air (RA)	5°C-40°C 80%RH or less									

*1: Because these models can support only old communication protocol, please communicate with local distributor if you want to connect these indoor units.

* Air volume can be changed over to high (Extra high) mode or low mode at both heat exchange and normal ventilation modes.
* Sound pressure level is measured 1.5 m below the center of the unit, and the value which was measured at the acoustic room.
* Sound pressure levels usually become higher than above values by the influence of actual installation condition such as reflected sound and peripheral noise.

* Sound power level is the value of casing.
*1) When the temperature of the outdoor air is below -10°C, the unit runs cold operation mode (intermittent operation of the ventilation for air supply). The unit cannot be used at -15°C or less. The ventilator for air supply stops, and the ventilator for air exhaust also can be stopped by the setting.

Drawings

Unit : mm

VN-M150HE to VN-M350HE

VN-M500HE to VN-M650HE

VN-M800HE to VN-M1000HE1

VN-M1500HE1 to VN-M2000HE1

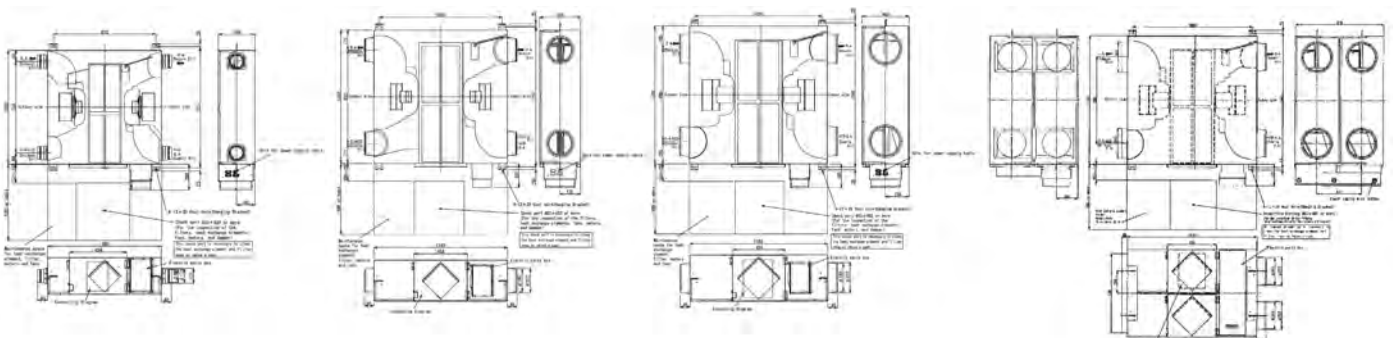

AIR-TO-AIR HEAT EXCHANGER

Sound pressure levels

Unit : dB(A)

VN-M150HE

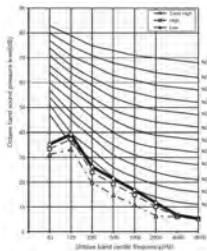

VN-M250HE

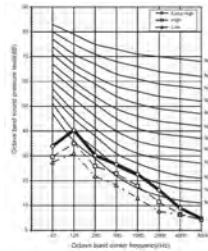

VN-M350HE

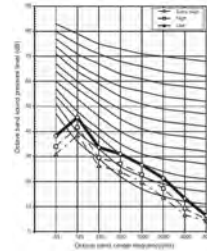

VN-M500HE

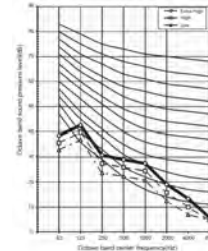

VN-M650HE

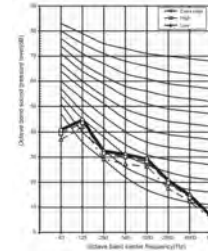

VN-M800HE

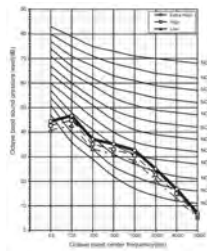

VN-M1000HE

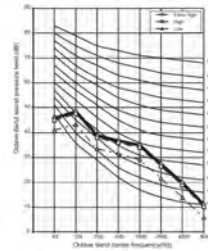

VN-M1500HE

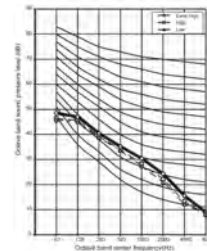

VN-M2000HE

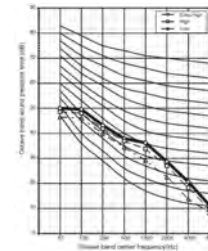

Accessories

Part name	Model name	Description	Appearance	Remarks
Control	NRC-01HE	All air-to-air heat exchangers dedicated remote control		Integrated functions : fan speed, freecooling, air balance volume rate, temperature management and timer.
	NRB-1HE	All air-to-air heat exchangers On/Off additional PCB		On/off optionnal PCB for air-to-air heat exchanger

Other information

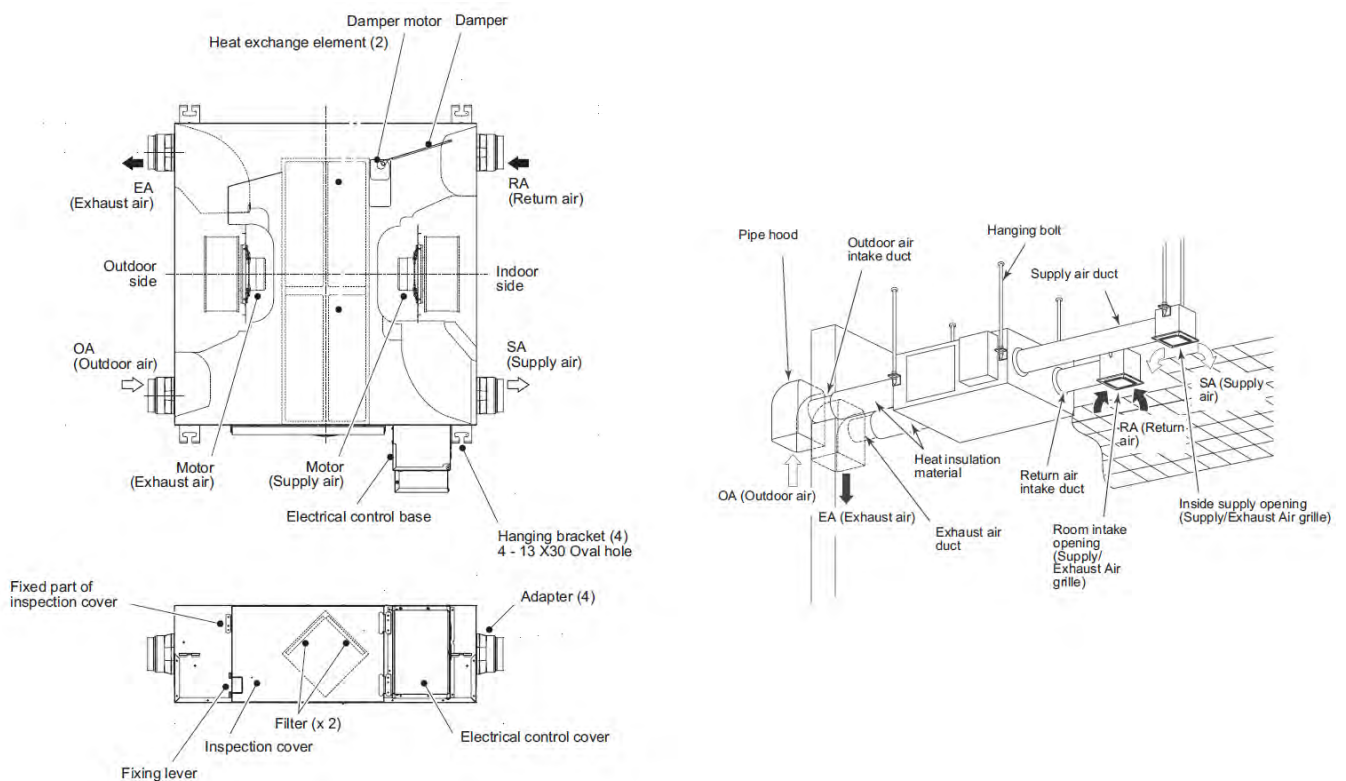

WIRELESS SOLUTIONS KEEP CONTROL



In addition to the high quality of the air conditioners, the controls also play a significant part in the ease-of-use and efficiency of the units. Optimized settings create the perfect climate. As well as local control options, Toshiba also offers a broad selection of central control systems or the option to integrate these in the building control system.

> ONE CONTROL FOR EVERY USAGE



Local controls

Cable remote controls (max. cable length 500 m) or wireless infrared remote controls are used to control individual units or groups of up to 8 indoor units. Additional modules allow units to be controlled from any location via apps or the Internet.

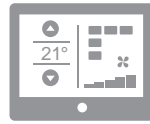

Central controls

VRF systems can be controlled from a preferred central location, such as the reception or plant room. Cable lengths can be max. 2,000 m and up to 512 indoor units can be controlled.



Building control systems

Toshiba air conditioners can be interlinked with all conventional building control systems. This makes air conditioning an integral part of the central control of a building.

> WHEREVER YOU ARE



On the cloud with Toshiba AC control app

Locally with standard remote control

Using Toshiba WebBrowser for all your facilities

> TRUST TOSHIBA TU2C-LINK

All control devices are connected to the air conditioner side using Toshiba's dedicated central control network, also called the TU2C-LINK. It can be used to directly connect all equipment.

Wiring: 2-core, non-polarity
Type: Shield wire
Size/length:
•1 to 1.5 mm² / Up to 1,000 m
•2 mm² / Up to 2,000 m

INDIVIDUAL REMOTE CONTROLLER

• : Available

TYPE		INFRARED								WIRED				
Part number		RBC-AXU31-E	RBC-AXU41U-E	RBC-AXU31U-E	RBC-AXU33UP-E	RBC-AXU31UM-E	RBC-AXU31UW-E	RBC-AX33UYP-E	RBC-AXU31C-E	RBC-ASCU11-E	RBC-AMTU31-E	RBC-AMSU31-ENES	NRC-01HE	
Picture														
Dimensions (HxWxD) in mm	Remote	157x56x19	157x56x19	157x56x19	157x56x19	157x56x19	157x56x19	157x56x19	157x56x19	86x86x16	120x120x16	120x120x20	120x120x16	
	Infrared receiver	120x70x18	204x204x24	163x163x24	204x204x24	163x163x24	71x162x39	140x113x12	130x65					
Compatibility		All indoor units	4 way cassette high performance	4 way cassette	4 way cassette	Compact 4 way cassette	2 way cassette	1 way cassette	Ceiling	All indoor units	All indoor units	All indoor units	Air to air heat exchanger	
Connectivity		1:1	1:1	1:1	1:1	1:1	1:1	1:1	1:1	1:16	1:16	1:16	1:8	
Standard functions	On/Off	•	•	•	•	•	•	•	•	•	•	•	•	
	Mode (heat, cool, ventilation, dry, auto)	•	•	•	•	•	•	•	•	•	•	•	•	
	Temperature setting	•/17°C-30°C	•/17°C-30°C	•/17°C-30°C	•/17°C-30°C	•/17°C-30°C	•/17°C-30°C	•/17°C-30°C	•/17°C-30°C	•/17°C-30°C	•/18°C-29°C	•/18°C-29°C	•/18°C-29°C	•/18°C-29°C
	Fan speed (auto, manual 5 speed)	•	•	•	•	•	•	•	•	•	•	•	•	
	Air direction (swing mode or manual orientation)	•	•	•	•	•	•	•	•	•	•	•	•	
Scheduling	Timer function	•	•	•	•	•	•	•	•	•	•	•	•	
	Schedule function									•	•	•	•	
	Return back											•	•	
Advanced functions	Dual set point											•	•	
	Soft cooling											•	•	
	Night operation											•	•	
	Energy save function										•	•	•	
	Frost protection										•	•	•	
	Lock function											•	•	
	Summer time											•	•	
	Room naming											•	•	
Installation & maintenance	Filter dirty indication									•	•	•	•	
	Error display	•	•	•	•	•	•	•	•	•	•	•	•	
	System settings									•	•	•	•	
	Indoor unit serial number											•	•	
Outputs	Error output									•	•	•	•	
	External ventilation control										•	•	•	
Display & Interface	Interface	Icon	Icon	Icon	Icon	Icon	Icon	Icon	Icon	Icon	Icon	Menu	Icon	
	Multilanguage											•	•	
	Luminous buttons											•	•	
	Backlight display											•	•	
Other	Temperature sensor									•	•	•	•	
Communication protocol										TU2C-LINK	TU2C-LINK	TU2C-LINK	TCC-LINK	

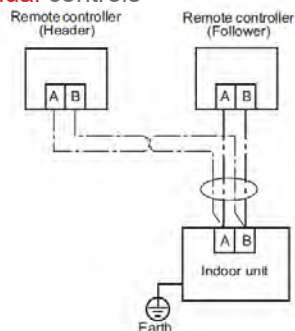

Installation drawings

Individual controls

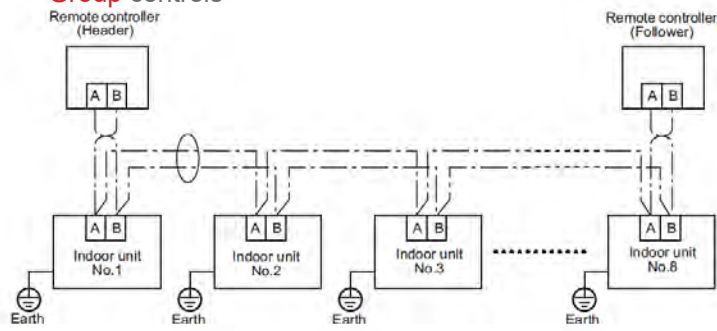

Group controls



TYPE		WIRED	
Part number		TCB-SC640U-E	BMS-SM1281ETLE - Smart Manager
Picture			
Dimensions (HxWxD) in mm		120x120x16	180x120x90
Compatibility		all systems	all systems
Connectivity		1:64	1:128
Standard functions	On/Off	•	•
	Mode (heat, cool, ventilation, dry, auto)	•	•
	Temperature setting	•	•
	Fan speed (auto, manual 5 speed)	•	•
	Air direction (swing mode or manual orientation)	•	•
Scheduling	Timer function		•
	Schedule function	•	•
	Return back		•
Advanced functions	Dual set point		•
	Soft cooling		•
	Energy save function		
	Energy monitoring		• (If power meter, BMS-IFWH5E interface relay needed)
Central control	Permit/prohibit function	•	•
	Group control	•	•
Installation & maintenance	Filter dirty indication	•	•
	Error display	•	•
	Error transfer by Email		•
	System settings	•	V
Display & Interface	Interface	Menu	Icon
	Multilanguage	•	•
	Luminous buttons	•	
	Backlight display	•	
Other	Digital Input/output		• (BMS-IFDD03E interface needed)
	Web connection		•
Communication protocol		TU2C-LINK	TCC-LINK

Drawings

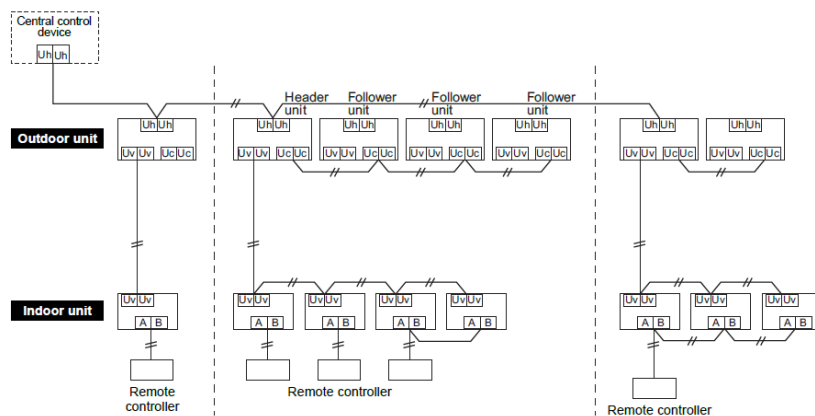

Focus on Web Browser

The Smart Manager can be remotely connected via a computer and all functions can be controlled via web browser:
 Standard operation - Advanced scheduling - Dual set point management - Up to 64 zones - Permit/Prohibit function - Energy saving - Return back



Focus on Data Analyzer

With or without power meter, the Data Analyzer software allows facility manager to manage system energy consumption. Through graphics on different periods, different indoor units, different energy consumption zones can be compared to optimize global efficiency. Set point, ambient temperature and outdoor temperature are monitored.

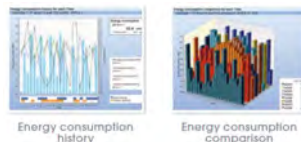

CLOUD SOLUTION

Part number	BMS-IWF0320E - Smart Device control interface	
App name	Toshiba AC control	
Picture		
Dimensions (HxWxD) in mm	140x90x45	
Compatibility	All indoor units (except hot water module, DX kit, fresh air, A2A heat exchanger)	
Connectivity	1:32	
Standard functions	On/Off	•
	Mode (heat, cool, ventilation, dry, auto)	•
	Temperature setting	•
	Fan speed (auto, manual 5 speed)	•
	Air direction (swing mode or manual orientation)	•
Scheduling	Timer function	•
	Schedule function	•
	Return back	•
Advanced functions	Energy save function	•
	Eco temperature schift	•
	Soft cooling	•
	Customize room/floor/building name	•
Central control	Permit/prohibit function	•
	Group control	•
Display & Interface	Interface	App
	Multilanguage	•
	App compatibility	Android & IOS
	Devices compatibility	Smartphone and Phablet
Installation & maintenance	Filter dirty indication	•
	Error display	•
	Error transfer by Email	•
Users	User acces	Login & Password
	Max user	1 admin / 32 users
Communication protocol	TCC-LINK	

Drawings

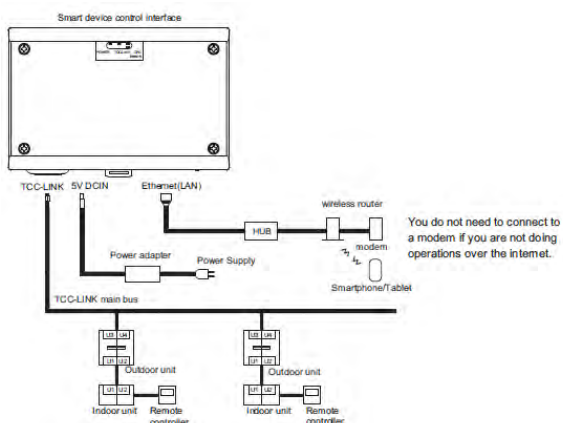

Level function	Administrator	User
Air conditioner's display	•	•*1
Air conditioner's settings	•	•*1, *2
Users sttings	•	-
Alarm	•	•*3
Schedule	•	-
Air conditioner's various settings	•	•*4
Clock settings	• (via intranet acces only)	-
Operation mode restriction	• (via intranet acces only)	-

*1: Only the air conditioners in the "Access Area" can be displayed.
 *2: If the locking setting is enabled, you cannot do any settings.
 *3: The alarm settings for "Access Area" can only be displayed.
 *4: The settings can only be displayed.

Toshiba AC control



Designed for commercial applications, the Toshiba AC Control App is your one-stop solution for managing up to 32 indoor units via an Android or iOS smartphone, with all main functions accessible in a single touch.

Mode (heating, cooling, ventilation, dry, auto)

Temperature set point, ambient temperature information

Fan speed (auto or manual)



On/Off



Louver control (fix or swing)



CONTROL

ADDITIONAL PCB

Additional PCB for outdoor units

Model name	Power peak-cut control board			External master ON/OFF control board			Output control board		
									
	TCB-PCDM4E			TCB-PCMO4E			TCB-PCIN4E		
System	SMMSu/ SMMS-7/SMMS [⊙]	SHRMe	MiNi SMMSe	SMMSu/ SMMS-7/SMMS [⊙]	SHRMe	MiNi SMMSe	SMMSu/ SMMS-7/SMMS [⊙]	SHRMe	MiNi SMMSe
Power peak cut control	•	•	•						
Power peak cut extend	•	•	•						
Snowfall fan control				•	•				
External master ON/OFF control				•	•	•			
Night operation (Sound reduction) control				•	•	•			
Operation mode selection control				•	•	•			
Error/Operation output control							•	•	•
Compressor operation output							•	•	•
Operation rate display							•	•	•
Max number installed	1	1	1	4	4	2	2	2	1
Kind of digital input / output	2/1			6/-			-/8		

Additional PCB for Indoor units

Optional connection kit TCB-PCUC2-E

SIGNAL

OUTPUT TERMINAL TB1

Signal outputs (Mode, fans status, alarm, defrost,...) are extracted from "OUT1", "OUT2", and "OUT3".

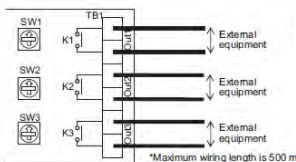

Connectable load: 30 VDC/1 A or less, 277 VAC/1 A or less

EXTERNAL

DIGITAL INPUT TERMINAL TB2

Stop air conditioner or lock local remote by inputting signal.

"Voltage OFF" input

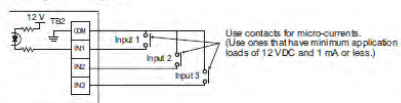

"Voltage ON" input

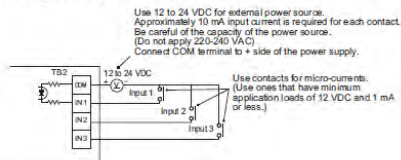

EXTERNAL

ANALOG INPUT TERMINAL TB3

Change the indoor unit's operation mode (AN1), set temperature (AN2), and blower setting (AN3) by connecting a variable resistor to the analog input terminal.

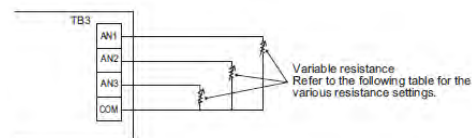



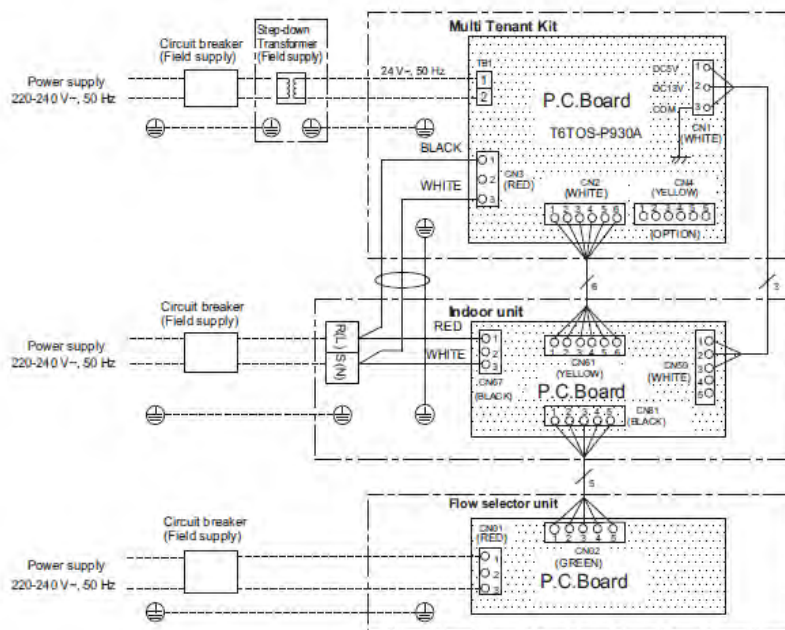

Multi tenant kit TCB-PSMT1E

For multi tenant application, this PCB maintain low voltage power during tenant absence when main power supply for the IDU is shut down.



CONTROL

Features

Part number		BMS-IFMB1280U-E	TCB-IFLN642TLE	BMS-IFBN1280U-E	TCB-IFCB640TLE
Langage		Modbus ®	LONWORKS ®	BACnet ®	Analogue and digital inputs
Picture					
Dimensions (HxWxD) in mm		170x200x66	193x246x66	90x140x45	66x170x200
Compatibility		All indoor units (HWM, A2A heat exchanger excluded)	All indoor units (HWM, A2A heat exchanger excluded)	All indoor units (HWM excluded)	All indoor units
Connectivity	Max number of indoor units	128	64	128	64
	Max number of outdoor units	16	16		
	Max number of gateways	15	10	1	
Command	On/Off	R/W	R/W	R/W	R/W
	Accumulated operation time	R/W			
	Mode (heat, cool, ventilation, dry, auto)	R/W	R/W	R/W	R/W
	Temperature setting	R/W	R/W	R/W	R/W
	Fan speed (auto, manual 5 speed)	R/W	R/W	R/W	R/W
	Air direction (swing mode or manual orientation)	R/W	R/W	R/W	R/W
	Soft cooling				
	Save operation				
	Filter dirty indication	R/W	R/W	R/W	
	Room temperature	R	R	R	
	Permit/Prohibit of local operation	R/W	R/W	R/W	
	Temperature setting range limitation	R/W			
	Error status	R	R	R	R
	Error code	R	R		
	Error address				
	Model name	R			
Serial number	R				
Indoor unit capacity	R				
Indoor unit type	R				
Protocol		Modbus RTU	Lontalk communication	Bacnet IP	Voltage signal
Infrastructure		RS-485	Twisted pair shield cable	LAN cable (higher than Category 5, UTP)	
Requirements (Locally supplied)		Modbus master device	Lonworks control system		
		Modbus master device	Lonworks Network Card for PC Control		
Toshiba communication protocol		TU2C-LINK	TCC-LINK	TU2C-LINK	TCC-LINK

BUSINESS / CONTROL SUMMARY

Controls

Model number	Reference	TCC-LINK	TU2C-LINK	Description	Used with
BMS-CT256U-E	7" Touch Screen Controller	x	x	Enables full control of up to 256 indoor units	
BMS-CT5121E	12" Touch Screen Controller	x		Enables full control of up to 512 indoor units with electric billing, ML	
BMS-IFBN1280U-E	BN Interface	x	x	BACnet Interface for LC & VRF	Enables integration with BACnet
BMS-IFDD03E	Digital I/O relay interface	x		Digital I/O relay interface	Touch screen controller, Compliant manager, Web based controller, Smart Manager
BMS-IFX0TLR-E	1:1 KNX interface	x		Connect the system to a KNX Building Management System	Remote Control wiring
BMS-IFLSV4E	TCS-Net Relay Interface	x		Relay for integration to TCS-Net	Bacnet gateway, Touch-screens & Web based controller
BMS-IFMB0TLR-E	1:1 Modbus interface	x		Connect the system to a Modbus Building Management System	Remote Control wiring
BMS-IFWH5E	Energy monitoring relay interface	x		Energy monitoring relay interface	Touch screen controller, Compliant manager, Web based controller, Smart Manager
BMS-IWF0320E	Smart Device Control Interface	x		Enables full control of up to 32 indoor units by using Toshiba AC app (Smart phone & Tablet)	
BMS-SM1281ETLE	Smart BMS Manager with data analyzer	x		Enables full control of up to 128 indoor units with Energy Monitoring and Advanced Control Options.	Network 1:1 model connection interface required for DI/SDI (Excluding high-wall type)
NRB-1HE	Remote ON/OFF adapter	x		Allows ON/OFF control	All Air-to-air heat exchangers
NRC-01HE	Wired Remote Controller	x		Air-to-air heat exchanger remote controller, including with DX coil and humidifiers models	Air-to-air heat exchangers and Air-to-air heat exchangers with DX coil
RBC-AMS41E	Remote controller with schedule timer	x		Indoor unit operation with schedule timer (7-days) allowing to program 8 functions/day + clock display	
RBC-AMSU51-EN/ES	Design remote Controller with schedule timer	x	x	Multi-Language LCD display, a built-in 7-Day timer, Energy Saving options and return back function, Dual set points, and Soft cooling. EN = English, Italian, Polish, Greek, Russian, Turkish. ES = English, Spanish, Portuguese, French, Dutch, German	
RBC-AMTU31-E	Wired Remote Controller	x	x	Main wired remote controller	
RBC-AMT32-E	Wired Remote Controller	x		Main wired remote controller	
RBC-AS41E	Simplified Wired Remote Controller	x		Dedicated for hotel and domestic applications	
RBC-AXU31C-E	Infra-red Remote Kit	x	x	Wireless remote controller	All ceiling units
RBC-AXU31U-E	Wireless remote unit kit	x	x	Wireless remote unit kit for 4-way cassette	4 way cassette series 1 & RBC-U32PGP-E
RBC-AXU33UP-E	Wireless remote unit kit	x	x	Wireless remote unit kit for 4-way cassette	4 way cassette series 1 & RBC-U33P-E
RBC-AX33UYP-E	Wireless remote kit	x	x	Wireless remote kit for YHP 1-way cassette	
RBC-AXU31-E	Infra-red Remote Kit	x	x	Wireless remote controller	All units
TCB-IFCB-4E2	Remote location On/Off Control Box	x		Enables remote location On/Off control	
TCB-IFCB5-PE	Window Switch & Remote on/off	x		Ensure the indoor unit not operate when outside window is open or for Door Entry systems	
TCB-IFCB640TLE	Analog interface	x		Control & monitoring up to 64 IU on TCC-link	Combination with TCB-IFCG1TLE
TCB-IFCG1TLE	General purpose interface	x		Enables control of A/C by the DI/DO and AI/AO	Combination with TCB-IFCB640TLE
TCB-IFLN642TLE	LN interface	x		Allows control of 64 indoor units from a Lonworks based BMS	
BMS-IFMB1280U-E	Modbus interface box	x	x	Connect the system to a Modbus Building Management System	
TCB-KBCN32VEE	Connectors	x		For CN32	
TCB-KBCN60OPE	Connectors	x		For CN60	
TCB-KBCN61HAE	Connectors	x		For CN61	
TCB-KBCN70OAE	Connectors	x		For CN70	
TCB-KBCN73DEE	Connectors	x		For CN73	
TCB-KBCN80EXE	Connectors	x		For CN80	
TCB-PCDM4E	Application Control PC Board	x		Power Peak Cut Control	
TCB-PCIN4E	Application Control PC Board	x		Error/Individual compressor Operation Output Control Board	
TCB-PCMO4E	Application Control PC Board	x		External Master ON/OFF Control Board	
TCB-PCUC2E	Optionnal connection kit	x			
TCB-PSMT1E	Optionnal connection kit	x		Multi-Tenant Kit for VRF Systems	SMMS-u, SMMS-∞, SMMS-e, SHRM-e and Mini-SMMS Indoor Units (refer to I/M for more details of connectable Indoor units)
TCB-PX100-PE	Enclosure for the Window Switch / Remote On/Off	x		For use when the Window Switch / Remote On/Off Accessory cannot fit within the AC unit, eg. High Walls	For use with TCB-IFCB5-PE
TCB-PX30MUE	E-Box Extension Enclosure	x		For 1:1 Model connection I/F and Window Switch / Remote On/Off PCB	4-Way Cassettes only & TCB-IFCB5-PE
TCB-PX40MUE	E-Box Extension Enclosure	x		For 1:1 Model connection I/F and Window Switch / Remote On/Off PCB	4-Way Compact Cassettes only & TCB-IFCB5-PE
TCB-SC640U-E	Centralized remote controller	x	x	Up to 64 indoor units	
TCB-TC41U-E	Remote temperature sensor	x	x	Remote temperature sensor for cassette & duct	
RBC-ASC11U-E	Wired Remote Controller	x	x	Main wired remote controller	
RBC-ASC11-E	Wired Remote Controller	x		Main wired remote controller	

ACCESSORIES

Indoor units accessories

Indoor unit type	Parts name	Model name	Applied model	Notes	Remarks
4-way cassette high performance	Ceiling Panel	RBC-U41PG(W)-E	MMU-UP_1H-E	Required accessory	
	Wireless remote controller	RBC-AXU41U-E		For installing on panel	
	Wireless remote controller	RBC-AXU31-E		For installing as stand alone	
	Fresh air chamber	TCB-GFC1603UE			
	Spacer for height adjustment	TCB-SP1603UE			
	Air discharge direction kit	TCB-BC1603UE			
4-way cassette	Ceiling Panel(Wide-flow louver)	RBC-U32PGP-E	MMU-UP_1HP-E	Required accessory	
	Ceiling panel (Smart design)	RBC-U33P-E		Required accessory	
	Wireless remote controller	RBC-AXU31U-E		For installing on panel	Use with RBC-U32PGP-E
	Wireless remote controller	RBC-AXU31-E		For installing as stand alone	
	Fresh air chamber	TCB-GFC1602UE			Use with TCB-GB1602UE
	Fresh air inlet box	TCB-GB1602UE		For fresh air intake by using the knockout hole of Fresh air and filter chamber. (dia.=100 mm)	Use with TCB-GFC1602UE
	Auxiliary fresh air flange	TCB-FF101URE2		For easy fresh air intake by using the knockout hole of indoor unit. (dia.=100mm)	
	Spacer for height adjustment	TCB-SP1602UE		Height 50 mm	
	Air discharge direction kit	TCB-BC1602UE		Air direction change by cutting off air discharge port (3 pcs.)	
	PM2.5 filter	TCB-PLFC1UPE-120		Before Pre-Filter type	
		TCB-PLFC2UPE-80		After Pre-Filter type	
	Wireless remote controller	RBC-AXU33UP-E		*New product and coming soon	Use with RBC-U33P-E
	Occupancy sensor	TCB-SIR33UP-E		*New product and coming soon	Use with RBC-U33P-E
	Air purifier kit	TCB-EAPC1UCP-E		*New product and coming soon	Use with RBC-U33P-E
Compact 4-way cassette	Standard panel	RBC-UM21PG(W)-E	MMU-UP_1MH-E	Required accessory	
	Motion Sensor	TCB-SIR41UM-E		Wireless remote controller kit (RBC-AX32UM(W)-E) and Occupancy sensor cannot be used on the same indoor unit.	
2-way cassette	Standard panel	RBC-UW283PG(W)-E	MMU-UP0071 to 0151WH-E	Required accessory	
		RBC-UW803PG(W)-E	MMU-UP0181 to 0301WH-E		
		RBC-UW1403PG(W)-E	MMU-UP0361 to 0561WH-E		
	Auxiliary fresh air flange	TCB-FF151US-E	MMU-UP_1WH-E	For easy fresh air intake by using the knockout hole of indoor unit	
	Filter chamber	TCB-FC283UW-E	MMU-UP0071 to 0151WH-E		
		TCB-FC803UW-E	MMU-UP0181 to 0301WH-E		
		TCB-FC1403UW-E	MMU-UP0361 to 0561WH-E		
	Super Long life filter	TCB-LF283UW-E	MMU-UP0071 to 0151WH-E	For use with filter chamber	Use with TCB-FC283UW-E
TCB-LF803UW-E		MMU-UP0181 to 0301WH-E	Use with TCB-FC283UW-E		
TCB-LF1403UW-E		MMU-UP0361 to 0561WH-E	Use with TCB-FC283UW-E		
1-way cassette	Ceiling Panel	RBC-UY32P-E	MMU-UP0071 to 0121YHP-E	Required accessory	
		RBC-UY42P-E	MMU-UP0151 to 0271YHP-E	Required accessory	
	Auxiliary fresh air flange	TCB-FF101URE2	MMU-UP0151 to 0271YHP-E	For easy fresh air intake by using the knockout hole of indoor unit. (dia.=100mm)	
	Air purifier kit	TCB-EAPC1UYHP-E	MMU-UP_1YHP-E		
	Occupancy sensor	TCB-SIR41UYHP-E			
	Wireless remote controller	RBC-AX33UYHP-E		For installing on panel	
	Wireless remote controller	RBC-AXU31-E		For installing as stand alone	
Slim duct	Auxiliary fresh air flange	TCB-FF101URE2	MMD-UP_1SPHY-E	For easy fresh air intake by using the knockout hole of indoor unit. (dia.=100mm)	
Concealed duct	Spigot shaped flange	TCB-SF56C6BE	MMD-UP0071 to 0181BHP-E		
		TCB-SF80C6BE	MMD-UP0241 to 0301BHP-E		
		TCB-SF160C6BE	MMD-UP0361 to 0561BHP-E		
Concealed duct high static pressure	Long life filter kit	TCB-LK801D-E	MMD-UP0181 to 0271HP-E		
		TCB-LK1401D-E	MMD-UP0361 to 0561HP-E		
		TCB-LK2801DP-E	MMD-UP0721 to 0961HP-E		
	Spigot shaped flange	TCB-SF80C6BE	MMD-UP0181 to 0271HP-E		
		TCB-SF160C6BE	MMD-UP0361 to 0561HP-E		
	Auxiliary fresh air flange	TCB-FF151US-E	MMD-UP_1HP-E		
	Drain Pump kit	TCB-DP40DPE			

Indoor units accessories

Indoor unit type	Parts name	Model name	Applied model	Notes	Remarks
Ceiling	Drain pump kit	TCB-DP31CE	MMC-UP_1HP-E	Lift up to 600 mm	Use TCB-KP13, 23CE
	Elbow Piping kit	TCB-KP13CE	MMC-UP0151 to 0181HP-E		
		TCB-KP23CE	MMC-UP0241 to 0561HP-E		
	Wireless remote controller	RBC-AXU31C-E	MMC-UP_1HP-E	For installing on panel	
	Wireless remote controller	RBC-AXU31-E	MMC-UP_1HP-E	For installing as stand alone	
Fresh air intake	High-efficiency filter 65	TCB-UFM0481D-E	MMD-UP0481HFP-E	Dust collecting effect: 65% (NBS Colorimetric method)	Use with TCB-FC0481DF-E
		TCB-UFM1281D-E	MMD-UP0721 to 1281HFP-E		Use with TCB-FC1281DF-E
	High-efficiency filter 90	TCB-UFH0481D-E	MMD-UP0481HFP-E	Dust collecting effect: 90% (NBS Colorimetric method)	Use with TCB-FC0481DF-E
		TCB-UFH1281D-E	MMD-UP0721 to 1281HFP-E		Use with TCB-FC1281DF-E
	Stand alone long life prefilter	TCK-LK1401D-E	MMD-UP0481HFP-E		
		TCK-LK2801DP-E	MMD-UP0721-1281HFP-E		
Filter chamber	TCB-FC0481DF-E	MMD-UP0481HFP-E	For high efficiency filter or long life prefilter		
	TCB-FC1281DF-E	MMD-UP0721 to 1281HFP-E			
	Drain pump kit	TCB-DP40DFP-E	All models	Lift up to 330 mm	
Air-to-air heat exchanger with Dx-coil	Drain pump kit	TCB-DP31HEXE	MMD-VN502/802/1002HEX1E & MMD-VN1002HEX1E2	Lift up to 330 mm	

Refrigerant accessories

Model name	Specification	Picture	Total capacity codes
Compatible SMMS [∞]			
RBM-BY55E	Branching joint		under 6.4 HP
RBM-BY105E			from 6.4 to 14.2 HP
RBM-BY205E			from 14.2 to 25.2 HP
RBM-BY305E			from 25.2 to 61.2 HP
RBM-BY405E			61.2 HP or more
RBM-HY1043E	Headers branching four-way		< 14.2 HP
RBM-HY2043E			< 14.2 - 25.2 HP
RBM-HY1083E	Headers branching eight-way		< 14.2 HP
RBM-HY2083E			< 14.2 - 25.2 HP
RBM-BT14E	Joints for connection of outdoor units		< 26 HP system capacity
RBM-BT24E			> 26 < 62 HP system capacity
RBM-BT34E			> 62 HP system capacity

SMMS[∞] piping

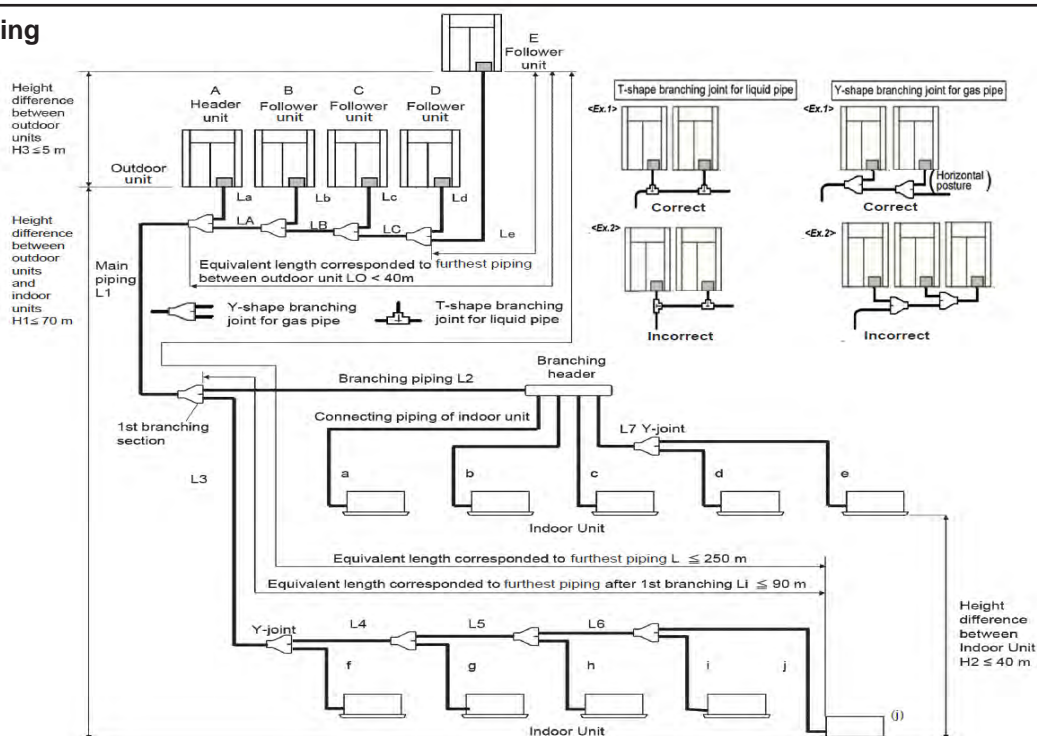

SYSTEM RESTRICTION

		SMMS-6	SMMS-7
Outdoor unit combination		Up to 5 units	Up to 3 units
Total capacity of outdoor units		Up to 120HP	Up to 60HP
Indoor unit connection		Up to 128 units	Up to 64 units
Total capacity of indoor units	H2 ≤ 15m	Max. 200%	Max. 200%
	15m > H2	105%	105%

T-shape branching joint for liquid pipe

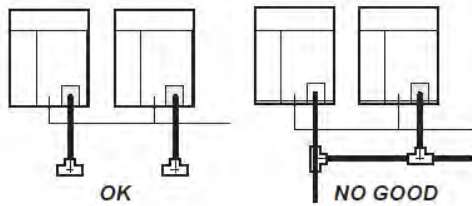

Y-shape branching joint for gas pipe

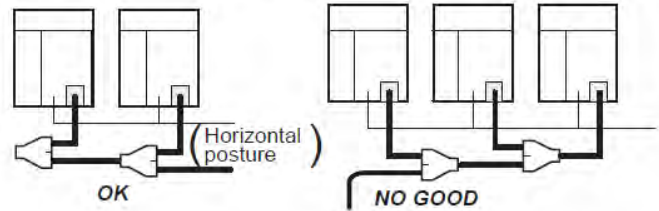

CAUTION FOR INSTALLATION

Be careful of the connecting arrangement of the header unit and follower units. Set the outdoor units in order of capacity from the one with the largest capacity.

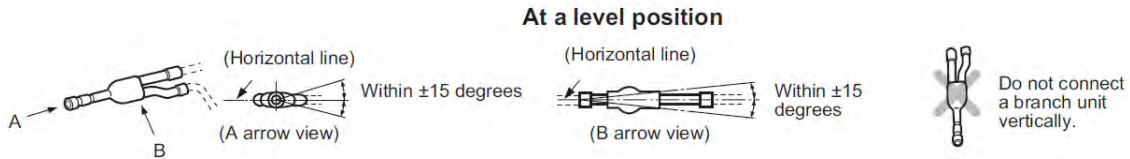

FREE BRANCHING SYSTEM

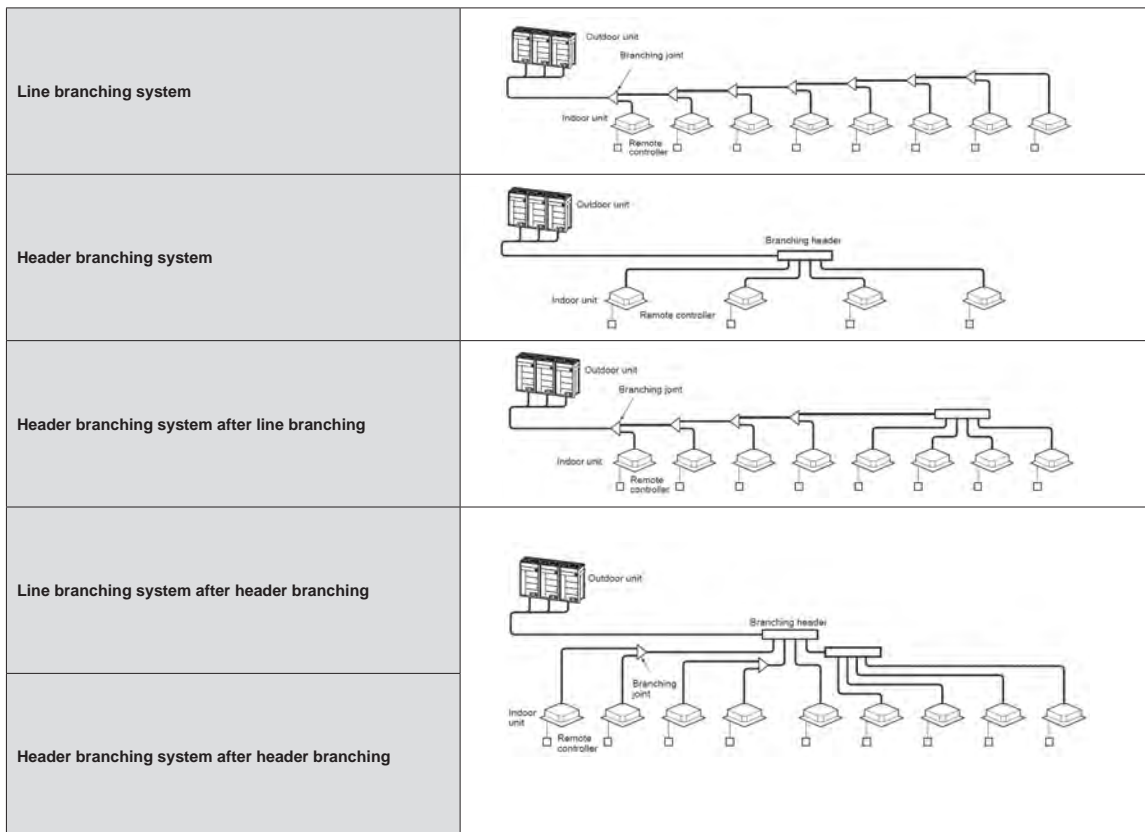

Electrical wiring

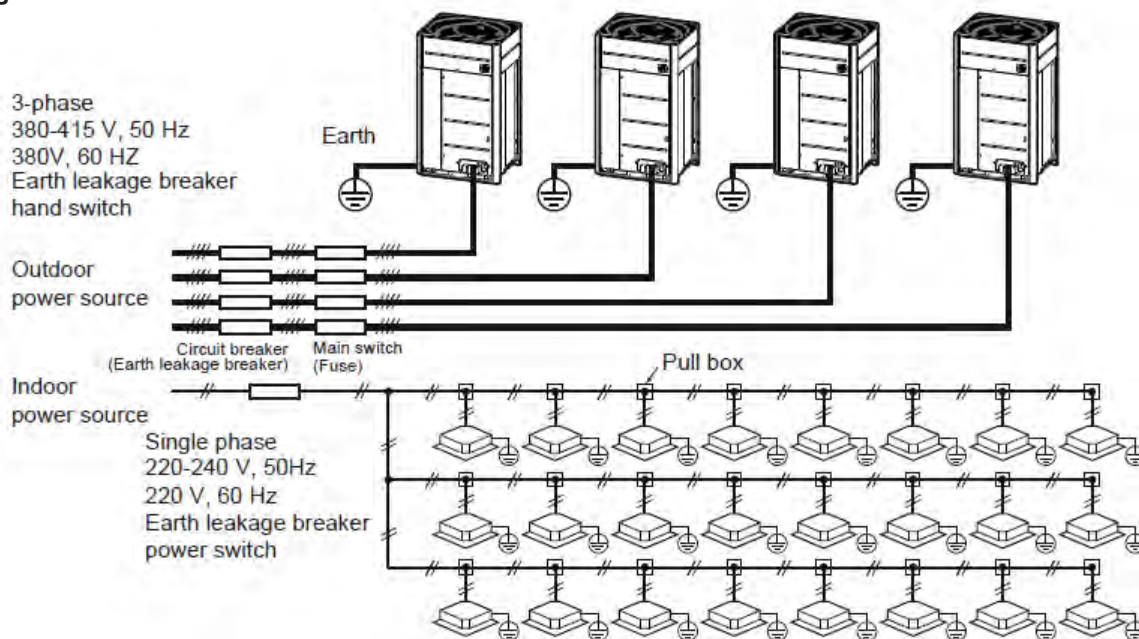

Sound pressure level measurement

SMMS[®]

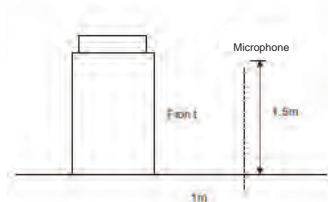

COMPACT 4-WAY CASSETTE & SMART 4-WAY CASSETTE & 4-WAY CASSETTE & 2-WAY CASSETTE & 1-WAY CASSETTE

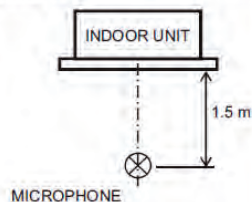

HIGH-WALL & CEILING

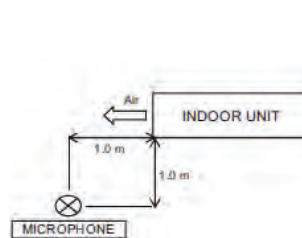

CONSOLE & BIFLOW CONSOLE

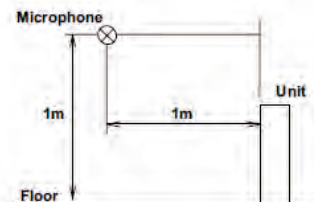

CONCEALED CHASSIS

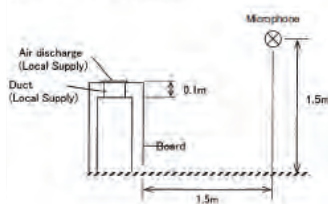

FLOOR STANDING

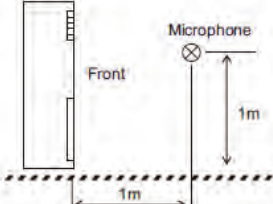

SLIM DUCT & STANDARD DUCT & HIGH STATIC DUCT

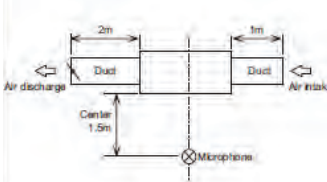

HIGH STATIC DUCT SIZES 72 & 96

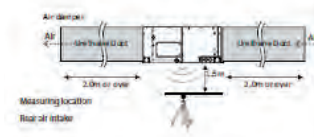

FRESH AIR

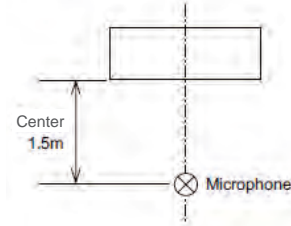

A2A HEAT EXCHANGER

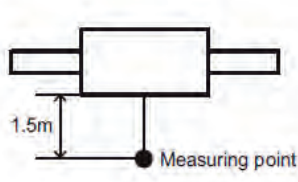

ZONING AIRCONDITIONING UNIT AUTO FLAP TYPE

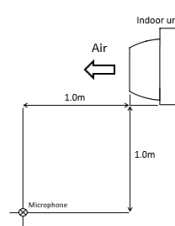

ZONING AIRCONDITIONING UNIT DUCT FLANGE TYPE

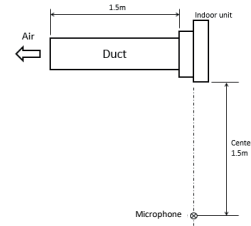



SOFTWARE

SELECTION TOOL



Software main screen

Toshiba Selection software has been fully designed, with a user-friendly interface allowing novice and expert users alike to create simple, yet detailed VRF system schematics. It is highly versatile, allowing the level of detail to be tailored to suit customer requirements. The software also allows the user to specify pricing strategy and create additional interim reports, including any diagrams and schematics required. Final detailed reports can then be produced and sent to customers in PDF format or in more complex files, such as AutoCAD DXF, allowing simple integration into their existing software packages.

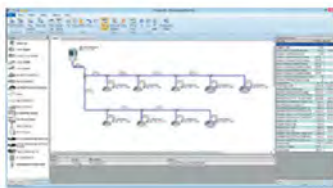

Project fully customizable



Complete report



SERVICE TOOL

Save time during commissioning and maintenance. Choose between the "Wave Tool Advance" using Smartphone NFC connection or the link adaptor connected to the outdoor or indoor unit.

NEW Application
Wave Tool Advance

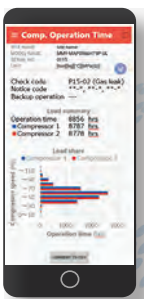

Wireless connection using smartphone* NFC technology to collect system data

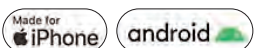

Get access to system data from indoor unit using link adaptor

Direct USB connection to get access to system data

System operation self record using link adaptor



PT Berca Carrier Indonesia

Head Office:

Gedung Pusat Niaga 4th Floor, Arena PRJ Kemayoran,
Jakarta 10610, Indonesia. Telp. (+62) 21 2664 5888

Service & Parts Center:

Jalan Agung Timur II, Blok O-1, No. 40 - 41 Sunter,
Jakarta 14350, Indonesia. Telp. (+62) 21 2660 8088

 contact@carrier.co.id

 www.carrier.co.id

Dealer:



Better Air Solutions

Through our commitment to world-class **efficiency**, versatile **scalability** and leading **quality**, Toshiba Air Conditioning advances leading-edge technologies to find the most forward-thinking solutions possible for your world.



MASCI
ISO 9001 QMS18026/1686
ISO 14001 EMS18012/471
ISO 45001 OHSMS19061/078

Notice: - Products listed in this catalogue use HFC refrigerant R410A with a GWP of 2,088*.

- Toshiba is committed to continuously improving its products to ensure the highest quality and reliability standards, and regulations and market requirements. All features and specifications are subject to change without prior notice.

*The GWP value is calculated based on information provided in the EU F gas Regulation and IPCC Fourth Assessment Report.

T2022-C02-SMMS[®]